



FEIF General Rules and Regulations

Valid as of April 1, 2019

Contents

Introduction	1
GENERAL REGULATIONS	7
G1 Code of Ethics and Code of Conduct (FEI)	8
G1.1. Introductory remarks	8
G1.2. Ethics statement	8
G1.3. Code of Conduct: Welfare of the horse	9
G1.3.1 General Welfare:	9
G1.3.2 Fitness to compete	10
G1.4. Veterinary Rules	10
G1.5. Fair Play and Equestrian Sport	11
G1.6. Suspension of Officials	12
G2. Riders, Judges and Officials	13
G2.1. Riders	13
G2.1.1. General	13
G2.1.2. Punctuality	13
G2.1.3. Liability	13
G2.1.4. Eligibility of riders	13
G2.1.5. Helmets	13
G2.1.6. About riders in sport events	14
G2.1.7. About riders and handlers at breeding shows	14
G2.2. Judges	14
G2.2.1 Sport judges	14
G2.2.2 Breeding judges	15
G2.3. Officials	15
G2.3.1 Ring Master	15
G2.3.2 Ring Steward	15
G2.3.3 Speaker	15
G3. The Icelandic horse	16
G3.1. Description of the Icelandic horse breed	16
G3.2. Description of the Gaits	16
G3.2.1 Walk	17
G3.2.2 Trot	18
G3.2.3 Canter	20
G3.2.4 Tölt	22
G3.2.5 Pace	23
G3.3. Certification of origin	24
G3.4. Official and international Database: WorldFengur FEIF/BÍ	25
G3.4.1 Nature and purpose of WorldFengur Rules	25
G3.4.2 International co-operation	25
G3.4.3 Entries in the register	25



G3.5.	Registration and identification of the horse	26
G3.5.1	FEIF International Identification Number (FEIF ID)	26
G3.5.2	Certificate of Origin / Horse Passport	27
G3.5.3	Breeding program for Icelandic horses	28
G3.5.4	Registration of horses born outside Iceland	28
G3.5.5	Registration of imported horses	28
G3.5.6	The naming of Icelandic horses in WorldFengur	29
G3.5.7	FEIF guidelines for embryo transfer	29
G3.6.	The FEIF WorldFengur registration group	29
G3.6.1	Terms of reference	29
G3.6.2	Specific Duties	29
G4.	Anti-Doping Procedures	31
G4.1.	Definition of Doping	32
G4.2.	EAD Rule Violations	32
G4.2.1	The presence of a Banned Substance and/or its Metabolites or Markers in a Horse's Sample	32
G4.3.	Proof of EAD Rule Violations	33
G4.3.1.	Burdens and Standards of Proof	33
G4.3.2.	Methods of establishing facts and presumption	33
G4.4.	The Equine Prohibited Substances List	34
G4.4.1.	Incorporation of the Equine Prohibited Substances List	34
G4.4.2.	Review and Publication of Banned Substances and Banned Methods Identified on the List	34
G4.4.3.	Substances and Methods included on the List	34
G4.5.	Testing	35
G4.5.1.	Authority to Test	35
G4.5.2.	Responsibility for FEIF testing	35
G4.5.3.	Testing Standards	35
G4.5.4.	Selection of Horses to be tested	35
G4.6.	Analysis of Samples	35
G4.6.1.	Use of Approved Laboratories	35
G4.6.2.	Purpose of Collection and Analysis of Samples	36
G4.6.3.	Research on Samples	36
G4.6.4.	Standards for Sample Analysis and Reporting	36
G4.6.5.	Retesting Samples	36
G4.7.	Results Management	36
G4.7.1.	Results Management for Tests arising out of FEIF Testing or other EAD Rule violations	36
G4.7.2.	Review of Atypical Findings	38
G4.7.3.	Review of Other EAD Rule Violations	38
G4.7.4.	Provisional Suspensions	38
G4.7.5.	Retirement from Sport	40
G4.8.	Right to a Fair Hearing	40
G4.8.1.	Hearings before the FEIF Disciplinary Board	40
G4.8.2.	Principles for a Fair Hearing	41
G4.8.3.	Waiver of Hearing	41
G4.9.	Automatic Disqualification of Individual Results	41



G4.10.	Sanctions	41
G4.10.1.	Disqualification of Results in the Event during which an EAD Rule Violation Occurs	41
G4.10.2.	Ineligibility and Fine for Presence, Use or Attempted Use or Possession of Banned Substances and Banned Methods	42
G4.10.3.	Elimination or Reduction of Period of Ineligibility Based on Exceptional Circumstances.....	43
G4.10.4.	Aggravating Circumstances Which May Increase the Period of Ineligibility	44
G4.10.5.	Multiple Violations.....	44
G4.10.6.	Disqualification of Results in Competitions Subsequent to Sample Collection or Commission of an EAD Rule Violation	46
G4.10.7.	Commencement of Ineligibility Period	46
G4.10.8.	Status During Ineligibility	47
G4.11.	Consequences to Teams.....	48
G4.12.	Appeals	48
G4.12.1.	Decisions Subject to Appeal	48
G4.12.2.	Appeals from Decisions Regarding EAD Rule Violations, Consequences, and Provisional Suspensions.....	48
G4.12.3.	Time for Filing Appeals	49
G4.13.	Application, Reporting and Recognition	49
G4.13.1.	Application of FEIF EAD Rules.....	49
G4.13.2.	Statistical Reporting.....	49
G4.13.3.	Public Disclosure	49
G4.13.4.	Recognition of Decisions by National Member Associations	50
G4.14.	Statute of Limitations	50
G4.15.	Amendment and Interpretation of EAD Rules	50
G5.	Events	52
G5.1.	FEIF events – general explanation	52
G5.2.	World Championships	52
G5.3.	Other Icelandic horse events	53
G5.3.1.	Mid European Championships.....	53
G5.3.2.	Nordic Championships	53
G5.3.3.	WorldRanking event	53
G5.3.4.	FEIF breeding show	53
G6.	World Championships - Approved Information	54
G6.1.	General	54
G6.2.	Allocation of responsibilities	55
G6.3.	Finances.....	55
G6.4.	Information	56
G6.5.	Sport competitions and breeding shows	56
G6.6.	Secretariat.....	57
G6.7.	Service for officials	57
G6.8.	Horses	58
G6.9.	Riders	58
G6.10.	Team Registration	58
G6.11.	Ceremonies.....	59



G6.12.	Social arrangements	59
G6.13.	Prizes	59
G6.13.1.	Breeding	60
G6.13.2.	Sport	60
G6.13.3.	Presentation of prizes.....	60
G6.14.	Advertisements	61
G6.15.	Veterinary rules	61
G6.16.	Doping	61
GENERAL RULES		62
G7.	Eligibility of horses	63
G7.1.	Appearance of the horse	63
G7.2.	Handling and training of the horse:	63
G7.3.	The age of a horse	63
G7.3.1.	Participating horses in breeding shows	63
G7.3.2.	Participating horses in sport events	64
G7.4.	Doping	64
G8.	Tack	65
G8.1.	Saddles	65
G8.2.	Bits and bridles	65
G8.2.1.	Breeding	65
G8.2.2.	Sport	65
G8.2.3.	Prohibited bits and bridles	65
G8.3.	Shoeing	66
G8.3.1.	Shoeing of Breeding Horses	66
G8.3.2.	Shoeing of Sport Horses.....	66
G8.4.	Additional equipment	68
G8.4.1.	The whip.....	68
G8.5.	Protective equipment	68
G8.5.1.	Breeding shows.....	69
G8.5.2.	Sport competitions	69
G9.	Tracks	70
G9.1.	Breeding - Tracks and facilities	70
G9.1.1.	Tracks for conformation judgements.....	70
G9.1.2.	Tracks for judgement of gaits/ridden abilities	70
G9.2.	Sport - Tracks	70
G9.2.1.	Oval track tests and details on tracks	70
G9.2.2.	Pace track tests and details on tracks	71
G9.2.3.	World Championship Tracks	71



G10.	Objections and Arbitration Rules	72
G10.1.	General Principles	72
G10.2.	Arbitration committees	72
G10.2.1.	Breeding shows.....	72
G10.2.2.	Sport events.....	72
G10.2.3.	World Championships	73
G10.3.	Rules of procedure for Arbitration Committees or disciplinary bodies of first instance	73
G10.3.1.	Objections at an Event.....	74
G10.4.	Appeals to the Arbitration Council	74
G10.5.	Appeals at national level	74
G10.6.	Guidelines for conflicts of interest - Breeding	75
G10.6.1.	Rules for employees of a breeding show	75
G10.6.2.	Guidelines for judges.....	75
G10.6.3.	Disciplinary measures and objections at breeding shows	76
G10.7.	Disqualifications and Disciplinary measures Sport	77
G10.7.1.	Scope.....	77
G10.7.2.	Register	77
G10.7.3.	Measures	77
G10.7.4.	Disqualifications and Disciplinary measures.....	78
G11.	Appendix 1: Codes of Conduct	80
G11.1.	Code of Conduct for Sport Judges at WorldRanking events	80
G11.2.	Code of Conduct for World Championship Judges	81



Introduction

The Icelandic horse offers a challenging riding experience for adults and children, and requires the highest standards of horsemanship in riding the five gaits; walk, trot, canter, tölt and flying pace (skeið) in nature, at competitions and in breeding shows. The aspiration to promote the Icelandic horse to its full potential is at the heart of FEIF's vision and mission.

VISION

FEIF is bringing people together in their passion for the Icelandic horse.

MISSION

We want to connect Icelandic horse culture, riding, lifestyle, enjoyment and passion.

We want to focus on horse welfare.

We want to provide pro-active service and knowledge.

We want to continuously improve and unify standards.

We want to promote the pure-bred Icelandic horse throughout the world.

We want to improve recognition of the Icelandic horse.



FEIF

The following diagrams explain the overall structure of FEIF and the standard documents on rules and regulations. Details on elections and decision powers can be found in the FEIF Statutes.

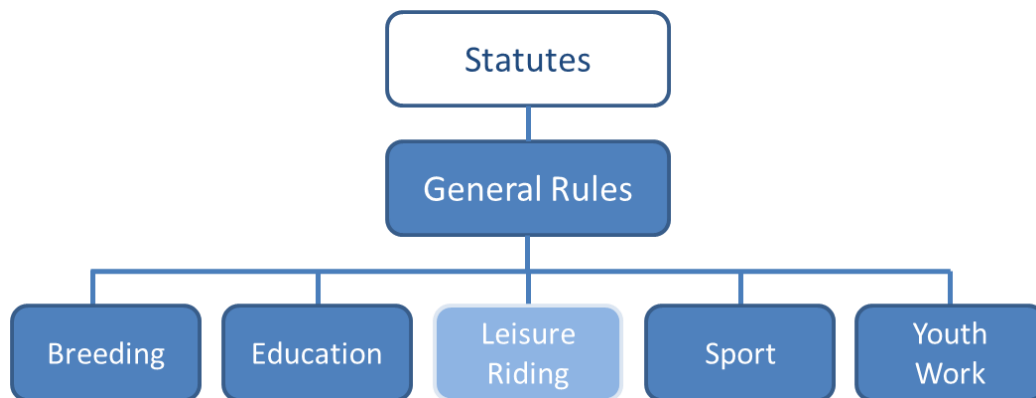
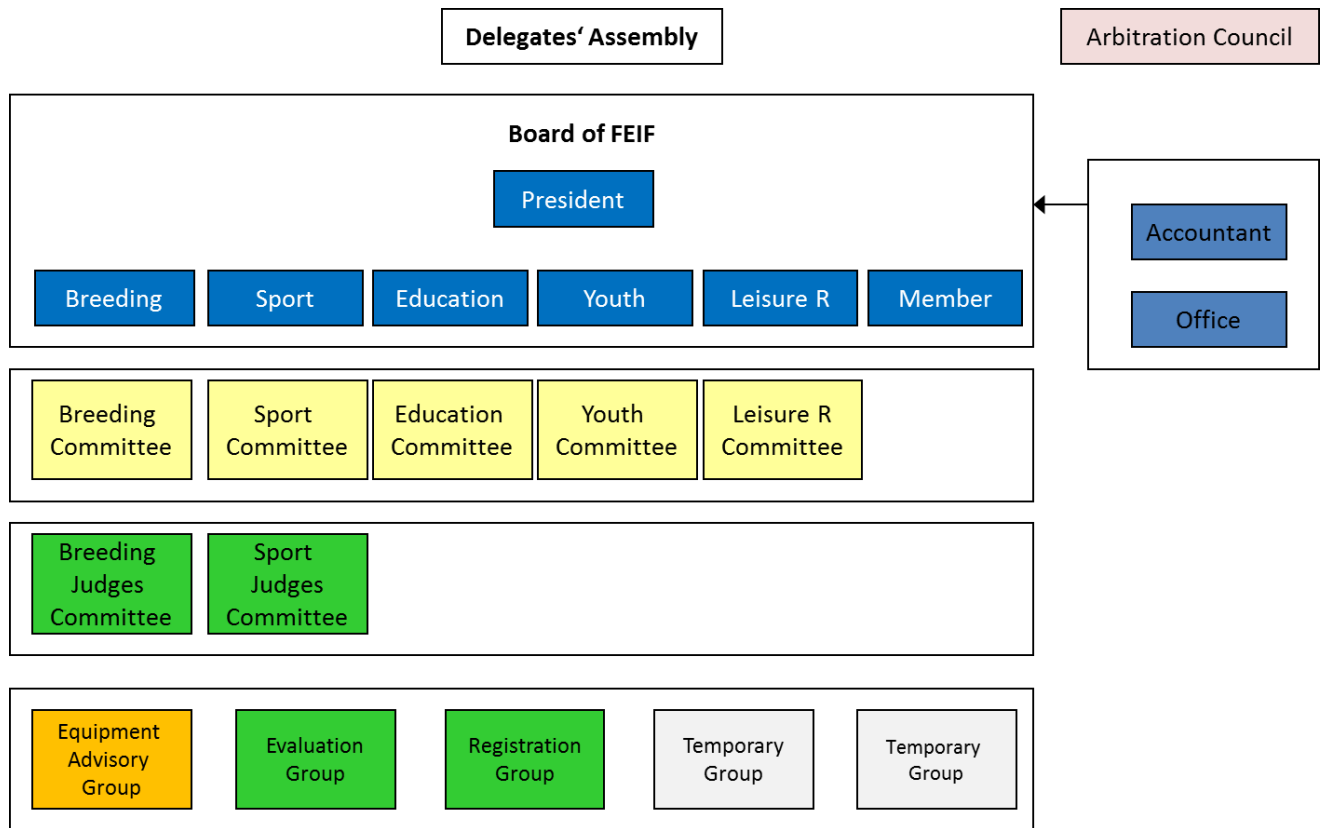

March 2019



1) Statutes

FEIF is the international federation of Icelandic horse associations founded on May 25th, 1969. The official language of FEIF is English.

2) Regulations and Rules

- This document contains the complete set of the FEIF Regulations and Rules valid for all departments and the current version is always published on www.feif.org.
- Any changes to the Regulations are subject to approval by the FEIF Board.
- Any changes to the Rules are subject to approval by the annual FEIF Delegates' Assembly.
- Rules are valid from the 1st of April to the 31st of March of any given year.
- All Rules and Regulations apply in all member countries of FEIF and supersede national rules.
- Specific rules governing sport and breeding are found in the chapters: 'sport rules' and 'breeding rules'. Further regulations on education, youth work (and leisure riding) are found in the respective sections

3) Breeding Rules

The Breeding Rules focus on all matters regarding breeding, including defining the breeding goals and evaluation of horses in breeding shows.

4) Sport Rules

The Sport Rules focus on all sport competitions involving the Icelandic horse.

5) Education

Education promotes the highest level of horsemanship for all Icelandic horse riders, handlers and judges. The Trainer and Instructor Matrix sets common standards for riding instructors, young horse and advanced horse trainers across all FEIF member countries

6) Youth Work

Youth work is central to the work of FEIF, and the Youth Committee oversees a number of international events that are organised nationally on behalf of FEIF.

7) Leisure Riding

Leisure Riding supports national work on maintaining access to ride in nature by sharing experience, ideas and concepts on events for leisure riders. In this context Leisure Riding interacts with other organizations within the equine sector. Leisure Riding focuses on describing the ideal characteristics of a good Icelandic leisure horse

8) Appendices

Appendices are under the control of the relevant committees and the FEIF Board, and can be changed by approval of the board, without having to go through the Delegates' Assembly.



Within FEIF there are separate ways of dealing with changes to rules and to regulations.

Rules are considered fundamental and any change to the rules require the approval of the General Assembly.

Regulations are of a more specific and detailed character and subject to the departments and shall be approved by the board of FEIF.

In more detail this may be described as below:

Procedure for Rule Changes

Many of the rules and regulations of FEIF are related to the established FEIF departments. These departments work in an advisory capacity to the Delegate's Assembly except where the rules give specific authority. In order for a rule change to be made the following must happen:

1. A change is proposed.
Any of the FEIF departments, member associations, committees or the Board of FEIF may propose a change to the rules. This proposal may be made at any time but is ideally made before the deadline for the final departmental agendas at the annual FEIF Conference are distributed.
2. The proposal is scheduled in the department meeting(s).
The relevant FEIF Directors schedule a discussion of the proposals in their departments. If a proposal is known at the time of the committee meetings in the Fall, the proposal is added to the committee meeting agenda so the committee's recommendations can be added to the discussion. If the proposal is presented after the committee meetings is it scheduled for the department meeting(s) at the FEIF Conference.
3. Recommendation to the Delegates' Assembly
Once the proposal is published in the department meeting agenda, all member associations have a chance to review the topic and form an opinion. During the department meetings the representatives share their national opinions and vote on the proposal. There is no restriction on the outcome of this vote. However, the three most common outcomes are:
 1. The proposal is recommended to the next Delegates' Assembly (which is held one year later).
 2. The proposal is sent to the committees for further work and expected to return to the next department meeting the following year.
 3. The proposal is rejected.
4. Delegates' Assembly
Once a proposal is approved at the department meetings it is sent to the next annual Delegates' Assembly. This means the proposal is again published this time in the DA agenda not the department agendas. The Delegates act on the proposal with the same basic options as are available to the department. The only essential difference is the Delegates' Assembly may not modify the proposal directly. The Assembly can make suggestions for modification but the modified text must be resubmitted to the next Assembly for action.



Procedure for Regulation changes

- A change is proposed.
Any of the FEIF departments, member associations, committees or the Board of FEIF may propose a change to the regulations. This proposal may be made at any time but is ideally made before the deadline for the final departmental agendas at the annual FEIF Conference are distributed.
- The proposal is scheduled in the department meeting(s).
The relevant FEIF Directors schedule a discussion of the proposals in their departments. If a proposal is known at the time of the committee meetings in the Fall, the proposal is added to the committee meeting agenda so the committee's recommendations can be added to the discussion. If the proposal is presented after the committee meetings is it scheduled for the department meeting(s) at the FEIF Conference.
- Recommendation to the Board of FEIF for final approval





GENERAL REGULATIONS



G1 Code of Ethics and Code of Conduct (FEI)

G1.1. Introductory remarks

All persons and corporate bodies (e.g. riders, judges, organisers, other officials, and associations) involved in Icelandic horse competitions and other Icelandic horse events are committed to fair, comradely and sportsmanlike behaviour to one another, and correct behaviour as a rider towards the horse. It is to be taken for granted, that the internationally established principles for the prevention of cruelty to animals are respected and adhered to unreservedly at all times.

G1.2. Ethics statement

FEIF brings people together in their passion of the Icelandic horse. In the process of doing so FEIF stresses the following principles, which have been adapted from the FEI values.

Respect for the horse

FEIF and its member associations put the welfare of the horse first in everything they do. Horse welfare receives focus through education, health and equipment checks at competitions and breeding shows, research on topics such as ideal hoof length, strict doping Rules and the FEIF veterinary committee, which provides advice on the welfare of our horses.

Equality

Equestrianism is one of the few sports where men and women compete on equal terms. There is no maximum age limit for competing athletes.

Fair Play

At all levels, only the best horse-rider combination should win fairly, having competed under even and equitable conditions and under Rules that are themselves fair, realistic, and applied with scrupulous care and even-handedness. No result can be meaningful or valid if it has not been achieved on “a level playing field”.

Cooperation with the horse

Equestrianism is the only sport that involves two athletes, equine and human. It is the successful partnership between these two elements; the relationship of confidence and respect that is built up between them, that makes the sport so exceptional.

Respect for the environment

The conservation of the environment is important to FEIF. We encourage all involved to follow the [FEIF Code of Conduct](#) towards the environment.



Principles translated into Codes of conduct

In order to turn these principles into practices we have outlined the behaviours we expect from FEIF officials, riders, participants, volunteers and spectators. Ethics are not dependent on a comprehensive set of Rules only, they come alive by the way we commit to our standards and act according to our principles. Beyond complying with a code of conduct, we ask each of us to be aware of these principles, to be aware of how difficult it can be to live up to them, and to support each other to make this our culture rather than a piece of paper.

All participants, riders, officials, trainers, instructors and others involved with our sport are expected to keep to the respective code of conduct. In some cases, they may be asked to sign a code of conduct to make their commitment clear. However, even without signing this, each person will be expected to have accepted the code of conduct by taking a certain position, or taking part in our events.

All types of artificial noisemaking devices are expressly prohibited at competitions and breeding assessments. Use of such devices may result in expulsion from an event.

G1.3. Code of Conduct: Welfare of the horse

This code of conduct is based upon the Codes of Conduct of the Fédération Equestre Internationale (FEI). In case of changes always the latest version of FEI applies.

The FEI requires all those involved in international equestrian sport to adhere to the FEI Code of Conduct* and to acknowledge and accept that at all times the welfare of the Horse must be paramount. Welfare of the horse must never be subordinated to competitive or commercial influences. The following points must be particularly adhered to:

G1.3.1 General Welfare:

- a. Good Horse management
Stabling and feeding must be compatible with the best horse management practices. Clean and good quality hay, feed and water must always be available.
- b. Training methods
Horses must only undergo training that matches their physical capabilities and level of maturity for their respective disciplines. They must not be subjected to methods which are abusive or cause fear.
- c. Farriery and tack
Foot care and shoeing must be of a high standard. Tack must be designed and fitted to avoid the risk of pain or injury.
- d. Transport
During transportation, horses must be fully protected against injuries and other health risks. Vehicles must be safe, well ventilated, maintained to a high standard, disinfected regularly and driven by competent personnel. Competent handlers must always be available to manage the horses.
- e. Transit
All journeys must be planned carefully, and Horses allowed regular rest periods with access to food and water in line with current FEI guidelines.

* https://www.fei.org/system/files/Code_of_Conduct_Welfare_Horse_1Jan2013_0.pdf



G1.3.2 Fitness to compete

a. Fitness and competence

Participation in presentation must be restricted to fit horses and athletes of proven competence. Horses must be allowed suitable rest period between training and competitions; additional rest periods should be allowed following travelling.

b. Health status

No Horse deemed unfit to compete may compete or continue to compete, veterinary advice must be sought whenever there is any doubt.

c. Doping and Medication

Any action or intent of doping and illicit use of medication constitute a serious welfare issue and will not be tolerated. After any veterinary treatment, sufficient time must be allowed for full recovery before presentation.

d. Surgical procedures

Any surgical procedures that threaten a competing horse's welfare or the safety of other horses and/or Riders must not be allowed.

e. Pregnant/recently foaled mares

Mares must not be presented after their fourth month of pregnancy or with foal at foot.

f. Misuse of aids

Abuse of a horse using natural riding aids or artificial aids (e.g. whips, spurs, etc.) will not be tolerated.

g. Bleeding

As the welfare of the horse is paramount in all competition, the moment a judge sees/realizes that a horse is actively bleeding during a test the judge must show the red card (not the vet card) and eliminate the horse from the test.

G1.4. Veterinary Rules

At competitions open for national and international riders, an official veterinary surgeon, who is responsible for the good health and well-being of the Icelandic horses taking part, must be appointed.

The horses taking part in Icelandic horse competitions must be free from any infectious or contagious disease and must not come from infected stock. Proof that the vaccination requirements according to the Veterinary Rules of FEI have been adhered to must be provided on request.

If a horse appears to the majority of the judges or to the veterinary surgeon to be unfit to compete (lameness, lack of fitness, doping etc.), the chief judge or the official veterinary surgeon can order a veterinary examination to be carried out. The decision on whether the horse is fit to compete rests with the official veterinary surgeon. There is no right of appeal.



G1.5. Fair Play and Equestrian Sport*

Fair play and equestrian sport

The equestrian disciplines, in common with other sports, depend heavily for their credibility, public acceptance and ultimate survival upon their adherence to the sportsman's code of fair play. Behind this precept lies the premise that the best man, woman or team should win fairly and squarely, having competed under even and equitable conditions and under Rules that are themselves fair, realistic, and applied with scrupulous competence and even-handedness. No result can be meaningful or valid if it has not been achieved "on a level playing field."

Translating the abstract ideals of fair play into practice requires the collaboration of all those who participate in any way in the competition, i.e., not only the competitors, officials, organisers and federations, but also even the owners, trainers, spectators and media. Each of these groups has an important role to play in enhancing both the image and the reality of equestrian sport, by respecting the spirit of fair play as embodied in the Rules and by insisting that the best interests of the sport and the welfare of the horse are placed above all else. Some additional considerations that especially concern particular groups are noted below:

Responsibilities of competitors, coaches and trainers

The competitors themselves play a highly critical role in promoting and safeguarding fair play in their sport. For whatever the responsibilities or actions of others, in the end it is the competitors who can most directly influence whether or not the play is fair by understanding all the Rules that govern their discipline, and by faithfully observing them even when nobody is watching.

High profile competitors must recognise how influential their example can be for others, and accept their responsibilities as role models. This applies to their actions both on and off the horse, and in the warm-up area as well as the competitive arena.

Coaches and trainers can also help to promote fair play by setting a good example and by discouraging disrespect for the Rules or acts of discourtesy by competitors under their supervision. Older advisers clearly exert as important an influence by their example as by their instruction.

Responsibilities of governing bodies

The governing bodies of equestrian sport not only formulate the Rules, but also qualify and license the officials, approve the dates and programmes of the major competitions, and often act as the final level of judicial authority. They must make every effort to ensure that their Rules are fair, based firmly on reality and applied accurately and consistently by officials of demonstrated competence and impartiality. They must also do everything they can to enhance and promote the quality of the disciplines and their attractiveness for spectators and competitors alike through a proactive use of their executive powers. Finally, they must recognise that neglect or disregard of the ideals of fair play reflects both on the sport and on the organisations responsible for its conduct.

* http://www.feicleansport.org/fair_play.html



Responsibilities of judges, stewards, veterinarians and all other officials

Officials exercise exceptional authority, which in turn requires them to assume exceptional responsibilities. Their overall effectiveness, no matter what their particular duties, depends not only on their technical competence and intimate knowledge of the Rules, but also on their maturity of judgment, self-control, flexibility and basic fairness and integrity. Beyond this, all officials must be scrupulously careful to guard against any appearance or actuality of conflict of interest. In all questionable cases it is always wiser to acknowledge a possible source of a conflict of interest and stand aside rather than permit suspicions to gain strength.

Responsibilities of journalists and other media

The media have their own standards of journalistic integrity, but have to work within the constraints imposed by editors, publishers and producers. Even so, they can make an important contribution to the public's appreciation of fair play through their reportage and commentary, and especially, by placing the events and incidents they cover into a fair and balanced perspective, and resisting the temptation to oversimplify or over-dramatize a story.

Responsibilities of spectators

Spectators attend equestrian events for their own pleasure, and cannot be denied the right to express their own feelings. Nonetheless, basic fairness should dissuade them from attempting to influence the performances of the horses or the decisions of the judges. Audiences should carefully avoid acts that might upset the horses, such as untimely movement, applause or flash photography, especially in venues that bring them into close proximity to the competitors.

All types of artificial noisemaking devices are expressly prohibited at competitions and breeding assessments. Use of such devices may result in expulsion from an event.

Though it is easy to more or less ignore the spectators and let them fend for themselves, it is important for them to be provided with programme material and commentaries that help them not only to understand what is going on, but also to appreciate the skill and sportsmanship of all the competitors, and to applaud even if their hero or favourite team is not winning. Every time the spectators are neglected, a precious opportunity to invest in the future of the sport has been lost, no matter how well everything else has been handled.

G1.6. Suspension of Officials

Any person serving FEIF in an official capacity including Board members, Committee members, persons elected by the Delegates' assembly, persons appointed by the Board of FEIF, and judges licensed by FEIF shall be placed on provisional suspension when under criminal charge for a violent or sexual offense. The suspension shall be made permanent if the person in question is convicted of the offense. All officials are obliged to self-report charges and convictions. Failure to do so shall result in an immediate, permanent suspension.



G2. Riders, Judges and Officials

G2.1. Riders

G2.1.1. General

A rider suspended in any one FEIF country for transgression of the Rules and ideals may not compete or show breeding horses in other FEIF countries until that suspension has been lifted. This is valid for sport and breeding, no matter in which the ban or warning was issued.

G2.1.2. Punctuality

A combination will be recorded as a “no show” if it fails to appear for its assessment after three calls within three minutes, providing the timetable has been kept to.

G2.1.3. Liability

Participation in all presentations is at the risk of the rider, holder or owner. Neither FEIF nor the organiser accepts any liability whatsoever.

G2.1.4. Eligibility of riders

Riders should be members of an organisation affiliated to FEIF.

For any event with age limitation the January of the year of birth is valid for the age of the rider.

In international competitions where there are no special classes for young riders, riders aged 16 (i.e. who turn 16 in the given calendar year) or over may compete in the adult classes.

A rider can only represent one country in a specific year for the purposes of “international” competition. (for types of competitions, see G5)

Any change of sport nationality must to be registered with FEIF before April 1 in a specific year using the form published on the FEIF website for this purpose.

Riders who are not listed by FEIF are assumed to have a sport nationality determined by their most recent participation in an international competition. This does not constitute a change of representation.

Upon the first change of representation, the change will be effective immediately. For further changes, a rider shall not have taken part in competitions for the country he previously represented in the two years prior to the first competition he wishes to compete in under his new representation. In special and exceptional circumstances, the Board of FEIF may grant exceptions for justifiable cases, with the agreement of the member associations concerned.

Riders who start in an international competition representing a nation other than that of their sport nationality will receive an immediate 6-months ban effective from date of the illegal start.

G2.1.5. Helmets

At all times when mounted at a breeding show and/or sport competitions riders must wear a riding helmet approved by the country hosting the event.



G2.1.6. About riders in sport events

Only the entered rider of a combination may mount a horse between arriving at the competition grounds and finishing the last entered test. Helpers are allowed to single-lunge or exercise the horse as long as they are not preparing the horse for a better performance. The Chief Judge may grant exceptions.

No one other than the horse and rider combinations may be present inside the collecting ring during the tests. Excepted from this is help with clothes and equipment before entering the track. The rider may not receive any outside assistance while competing.

The horse and rider combination must be the same in the preliminary and final rounds. However, if it is clearly set out in the invitation, the organiser may allow a rider to be substituted in the finals if he has qualified with more than one horse

- **Riders' dress/equipment**
At sport competitions riders should wear a riding jacket or plain sports pullover or waistcoat, riding breeches with riding boots or jodhpurs with Jodhpur boots. In pace race and pace tests, riders should wear riding breeches with riding boots or jodhpurs with Jodhpur boots, but otherwise may be dressed casually. Spurs are forbidden. At all times when mounted at a breeding show and/or sport competitions riders must wear a riding helmet approved by the country hosting the event.

G2.1.7. About riders and handlers at breeding shows

The same rider should present the same horse during the entire assessment. However, a new rider may present the horse in the 2nd assessment. Riders should be sober and show courteous riding and they, as well as the owners/handlers of the horse, shall be fair and courteous towards the show and its staff. If not, the jury can reprimand the persons in question, or dismiss them from the show.

G2.2. Judges

In most cases judges start at national level, and their training, examining structure and license system is regulated by national associations. The international level of all judges is regulated and licensed by FEIF.

G2.2.1 Sport judges

Sport judges are officials adjudicating at sport tournaments. Sport judges ensure that Rules are being followed, that events are carried out in the fair spirit of good sportsmanship and that the welfare of the horse is kept paramount at all times.

The sport judge licenses have various degrees, the license as a FEIF International Sport Judge being the most advanced. The responsibility for basic education, training and certification of sport judges at lower level lies with individual FEIF member associations. The sole right to certificate FEIF Licensed International Sport Judges lies with FEIF.

To become a FEIF Licensed International Sport Judge a candidate must pass an examination held by FEIF. The FEIF director of sport is responsible for the examination, both the content of the procedure and the examination's execution. Candidates for the examination must fulfil the requirements of participation and be entered by a FEIF member association, hold a license as a sport judge at a national level and be at least 21 years of age.

Once passed the examination, the candidate will receive a license as FEIF International Sport Judge for the period of three years.



In order to renew the license for another period of three years a FEIF International Sport Judge must fulfil requirements set by the Board of FEIF. A FEIF International Sport Judge is not obliged to be a member of a FEIF member association nor to resident in a FEIF member country to maintain his license.

FEIF International Sport judges are represented within FEIF by the Sport Judges Committee that operates under the auspices of the FEIF Director of Sport.

G2.2.2 Breeding judges

A highly experienced breeding judge, who is approved by a FEIF member association and has passed the qualifying FEIF test for international breeding judges. The sole right to certificate FEIF International Breeding Judges lies with FEIF.

G2.3. Officials

G2.3.1 Ring Master

Ring Masters support the judges in a practical sense. Ring Masters operate under the responsibility of the Head Judge of a test or the Chief Judge of the event. A Ring Master is preferably a judge.

At any event, a sufficient number of Ring Masters should be available.

- a. inspection of equipment and wounds
- b. inspections of training facilities and stabling areas

G2.3.2 Ring Steward

Ring Stewards support the organiser and the speaker in a practical sense. Ring Stewards operate under the responsibility of the tournament leader/organizer. At smaller events, the functions of Ring Stewards and Ring Masters may be combined.

At any event, a sufficient number of Ring Stewards should be available for:

- a. helping the speaker to keep the time schedule and the starting order
- b. supplying the speaker with information about the rein in finals
- c. informing riders about the progress of the current test or breeding show

G2.3.3 Speaker

The speaker is instrumental in moving an event along at the desired pace and according to its schedule, providing audibly all information on the objectives and content of any given test and its participants (horses and riders). All competitors and officials have to be treated with fairness and respect; the speaker must also be familiar with applicable rules for the event as well as common standards and practices, thus building a coordinating and helpful bridge between participants, officials and the audience. The speaker is available at all times for radio contact with the chief judge and is assisted with up-to-the-minute input from the secretariat (starting order), IceTest operator (results and updates) and Ring Masters.



G3. The Icelandic horse

G3.1. Description of the Icelandic horse breed

Origin

The Icelandic horse breed originates from Iceland where it has been bred, without any known introduction of foreign genetic material, since the island was settled around the year 900 AD. Its closest relatives today are assumed to be the native horse breeds of Scandinavia and horse breeds of the British Isles. The Icelandic horse is pure-bred with all ancestors traceable to Iceland.

Size

The height of the Icelandic horse generally ranges from 125 to 145 cm when measured with a stick at the highest point of the withers. The average for mares is 136 cm and for stallions 138 cm. The fully mature Icelandic horse weighs around 300 kg to 400 kg.

Colours

Most known horse colours and markings can be seen. The most dominant colours are chestnut, black and bay but grey and tobiano are also quite commonly found. More than one hundred colour varieties may be found in the Icelandic horse breed.

Conformation

Conformation may vary considerably but a typical Icelandic horse is rectangular and compact in shape. Typical of the breed is a sloping croup, a long, thick mane and tail, and a thick, protective coat in winter.

Performance

The Icelandic horse is a riding horse. The horse is unique in its gaits and virtually all Icelandic horses have tölt in addition to walk, trot, and canter/gallop. Many horses have the additional gait of very fast (flying) pace. As a riding horse it is extraordinarily versatile - a capable, willing horse for pleasure riding, and for sport competitions, suitable for adults and children. The horse is tough, independent, yet sociable and easy to get on with, is self-assured and has good staying power.

Longevity

The horse matures slowly and is generally not fully grown until the age of six or seven. It has a long active life span (25-30 years is not unusual).

Health

The overall health of the Icelandic horse is very good. Fertility is high and both sexes can be fit for reproduction up to the age of 25 to 27 years.

G3.2. Description of the Gaits*

The gaits of the Icelandic horse are defined here. These are basic definitions describing the beat, footfall sequence and movements in each stride. Ideal movements pertaining to each gait will be described, as well as deviations from the correct beat. The different speeds at which the horse should be shown in all existing disciplines covered by the FEIF Rules are described as well.

* The basic definitions are based on a study made by Gunnar Reynisson at the University of Hvanneyri. You can find the study *Definition of the Gaits* by Gunnar Reynisson at www.feif.org



G3.2.1 Walk

The walk is a symmetrical, four beat stepping gait with a lateral movement. Ideally it should have a regular rhythm with even time interval between ground contacts of each limb (that is, a forelimb lands about 1/4 of stride duration after the ipsilateral hind limb). The limb sequence is: left hind leg, left foreleg, right hind leg and right foreleg. It is a gait without suspension and has eight phases during the walk stride and the support phases alternate between bipedal and tripedal support.

Ideal movements in walk

In walk the horse should be supple and move energetically in an even four-beat with long strides, clearly resting in the steps. Head and neck move rhythmically up and down in balancing gestures and the horse's spinal column is springy and without tension. The horse is active in hind legs and back, body movements are obvious and the tail swings freely with each stride.

Faults in walk

A. Pacey walk

It is considered undesirable when the walk is pacey; when lateral limbs move forward almost simultaneously and the time interval between ground contacts of lateral legs is too short. Then the walk is said to have a lateral couplet, which is when the time interval between ground contacts of ipsilateral limbs is shorter than 1/4 of the stride duration.

B. Trotty walk

During walk it is also undesirable if the time interval between ground contacts of diagonal limbs is too short. In this case the walk has lost the purity of the four-beat and the walk is too close to trot. Then the walk is said to have a diagonal couplet, that is, when the time interval between ground contacts of lateral limbs is longer than 1/4.

C. Stiff walk

The rhythm is an even four-beat rhythm but the horse's body lacks suppleness. The back is inactive and stiff and the movements are not flowing through the body of the horse.

D. D. Rushed walk

It is a fault if the horse is not resting in each step and is rushing when walking.

Walk can be performed as follows:

A. Walk

The rider should have the riding skills necessary to allow the horse to show a clear-beat and energetic walk. The horse moves forward in an open form with a relaxed topline.

B. Medium walk

A clear, regular and unconstrained walk of moderate lengthening. The horse, remaining "on the bit", walks energetically with a long neck and rounded, relaxed topline with even and determined steps, the hind feet touching the ground in front of the hoof prints of the fore feet. The rider maintains a light, soft and steady contact with the mouth, allowing the natural movement of the horse's head and neck.



C. Collected walk

The horse, remains "on the bit", moves resolutely forward, with its neck raised and arched and showing a clear self-carriage. The head approaches the vertical position and a light contact is maintained with the mouth. The hind legs are engaged with good hock action. The pace should remain marching and vigorous, the feet being placed in regular sequence. The steps cover less ground and are higher than at the medium walk, because all the joints bend more markedly. The collected walk is shorter than the medium walk, although showing greater activity.

D. Extended walk

The horse covers as much ground as possible, without haste and without losing the regularity of the steps. The hind feet are clearly overreaching. The rider allows the horse to stretch head and neck (forward and downward) without losing contact with the mouth and control of the poll. The nose must be clearly in front of the vertical.

E. Free walk

The free walk is a pace of relaxation in which the horse is allowed complete freedom to lower and stretch out his head and neck. The degree of ground cover and length of strides, with hind feet stepping clearly in front of the footprints of the front feet, are essential to the quality of the free walk.

F. Stretching on a long rein

This exercise gives a clear impression of 'throughness' of the horse and proves its balance, suppleness, obedience and relaxation. In order to execute the exercise "stretching on a long rein" correctly, the rider must lengthen the reins as the horse stretches gradually forward and downward. As the neck stretches forwards and downwards, the mouth should reach more or less to the horizontal line corresponding with the point of the shoulder. An elastic and consistent contact with the rider's hands must be maintained. The pace must maintain its rhythm, and the horse should remain light in the shoulders with the hind legs well engaged. During the retaking of the reins the horse must accept the contact without resistance in the mouth or poll.

G3.2.2 Trot

Trot is a symmetrical two-beat, diagonal gait with a moment of suspension. Trot includes four phases. The horse moves the left hind leg and the right front leg (the right diagonal pair) together and the right hind leg and left front leg (the left diagonal pair) together. The diagonal support phases are separated by swing phases.

Ideal movements in trot

In trot the horse should have an arched neck and a rounded, relaxed topline. The horse should go forward with suppleness, impulsion, in even rhythm and with obvious suspension. Trot should possess roomy strides and be a pure two-beat gait. The back is elastic and the movement runs through the horse's body.

Faults in trot**A. Four-beat trot**

The most common fault with trot is a four-beat trot. The diagonal legs become dissociated. This can happen in two ways; the fore limb of the diagonal pair hits and leaves the ground before the hind limb. Then the hind limb of the diagonal pair can hit and leave the ground before the fore limb.



B. Loss of suspension in trot

The trot is also considered faulty when it has a pure beat but lacks a moment of suspension. In this case the horse maintains a pure two-beat rhythm, but hardly leaves the ground. This results in decreased swing phase and the horse becomes earthbound.

C. Lack of trunk movements in trot

It is a fault if trunk movements are lacking during trot. Then, action is lacking in the horse's back and the movement does not run through the horse's trunk like it should. The horse is a leg mover but not a body mover.

D. Irregular beat in trot

It is a fault if the trot has an irregular beat. The trot can be three-beat, i.e. one diagonal pair of limbs is dissociated but the other is not or, for instance, more or less mixed with canter. The movements of the left and right sides of the horse are not symmetrical and the trot does not show a pure two-beat.

Trot can be performed as described below.**A. Trot**

The rider should have the riding skills necessary to allow the horse to show a clear beat and energetic trot. The horse moves forward in an open form with a relaxed the topline. A slack of the rein/loose rein is recognized as long as the rhythm of the trot is maintained.

B. Working trot (previously described as slow trot)

This is a pace between collected and the medium trot, in which a horse's training is not yet developed enough and ready for collected movements. The horse shows proper balance and, remaining "on the bit", goes forward with even, elastic steps and good hock action. The expression "good hock action" underlines the importance of an impulsion originating from the activity of the hindquarters.

C. Collected trot

The horse, remaining "on the bit", moves forward with the neck raised and arched. The hocks, being well-engaged and flexed, must maintain an energetic impulsion, enabling the shoulders to move with greater mobility, thus demonstrating complete self carriage. Although the horse's steps are shorter than in the other trots, elasticity and cadence are not lessened.

D. Medium trot

This is a pace of moderate lengthening compared to the extended trot, but "rounder" than the latter. Without hurrying, the horse goes energetically forward with clearly lengthened steps, with impulsion from the hindquarters, good back bearing and high movements. The rider allows the horse to carry the head a little more in front of the vertical than at the collected and the working trot, and to lower the head and neck slightly. The steps should be even, and the whole movement balanced and unconstrained.

E. Extended trot

The horse covers as much ground as possible. Without hurrying, the steps are lengthened to the utmost as a result of great impulsion from the hindquarters. The rider allows the horse to lengthen the frame and to gain ground whilst controlling the poll. The fore feet should touch the ground on the spot towards which they are pointing. The movement of the fore and hind legs should reach equally forward in the moment of extension. The whole movement should be well-balanced and the transition to collected trot should be smoothly executed by taking more weight on the hindquarters.



F. Fast trot

During fast trot the horse extends its topline more; head and neck become extended. At high speed in trot diagonal legs can become dissociated and the forelimb then hits the ground slightly before the diagonal hind limb. Trot at high speed is still considered a two-beat gait since the divergence from synchronous movements of diagonal legs is not noticeable.

G3.2.3 Canter

Canter is an asymmetrical, three-beat gait with suspension. Canter has six phases, the footfall sequence being in right lead canter: left hind - right hind: left front - right front leg-suspension. The horse lands first on the left hind leg; then it lands simultaneously on right hind and left front leg (diagonal legs hitting the ground simultaneously) and last on the right front leg. The horse ends the stride with a moment of suspension after it has landed on the right front leg. The footfall sequence in left lead canter is: right hind leg - left hind leg: right front leg - left front leg - suspension. During canter the support phases alternate between uni-, bi- and tripedal support in a single stride.

Ideal movements in canter

A good canter has balance and light, supple movements. The horse should have an arched neck and rounded relaxed topline and engaged hindquarters. The movements of the front quarters are light and unconstrained. The horse has a clearly visible suspension and a pure three-beat rhythm.

Faults with canter**A. Four-beat canter**

The canter is faulty if it is four-beat. Then there is a dissociation of the diagonal limb pair with ground contact of the hind leg in advance of the diagonal foreleg.

B. Pacey canter

The canter is faulty, when it has a four-beat rhythm and the front leg of the diagonal pair lands before the hind leg. This is called a pacey or lateral canter. When this is the case, the horse is on the forehand and the lateral legs; the left fore and hind legs and the right fore and hind legs move almost together in a lateral movement.

C. Lack of trunk movements in canter

It is a fault if trunk movements are lacking during canter or gallop. Then, action is lacking in the horse's back and the movement does not run through the horse's trunk. The horse is a leg mover but not a body mover. This can happen when the horse is not uphill; the hindquarters are higher than the front part of the horse and suspension is obvious in the hind. The movements of the horse are stiff and the horse is on the forehand.

D. Disunited canter

Disunited or cross canter occurs when the footfall sequence is different from correct canter. If this happens during competition or a breeding judgment, the horse will receive a low or no mark for canter, depending on the duration of the disunited canter. The horse mixes right and left canter. The horse may have disunited canter on the left or the right lead. In the case of a left lead disunited canter the horse lands first on the left hind leg, then on right hind leg and right front leg and then on left front leg. In the case of right lead cross-canter the horse lands first on the right hind leg, then on left hind leg and left front leg and then on right front leg.



Canter can be performed as described below:**A. Canter**

The rider should have the riding skills necessary to allow the horse to show a clear beat and energetic canter. The horse moves forward in an open form with a relaxed topline. A slack of the rein/loose rein is recognized as long as the rhythm of the canter is maintained.

B. Working canter (formerly defined as slow canter)

This is a pace between the collected and the medium canter, in which a horse's training is not yet developed enough and ready for collected movements. The horse shows natural balance while remaining "on the bit", and goes forward with even, light and active strides and good hock action. The expression "good hock action" underlines the importance of an impulsion originating from the activity of the hindquarters.

C. Collected canter

The horse, remaining "on the bit", moves forward with the neck raised and arched. The hocks, being well-engaged, maintain an energetic impulsion, enabling the shoulders to move with greater mobility thus demonstrating self-carriage and an uphill tendency. The horse's strides are shorter than in the other canters, without losing elasticity and cadence.

D. Medium canter

This is a pace between the working and the extended canter. Without hurrying, the horse goes forward with a clear beat, clearly lengthened strides and impulsion from the hindquarters, good back bearing and high movements. The rider allows the horse to carry the head a little more in front of the vertical than in the collected and working canter, and at the same time allows the horse, to lower the head and neck slightly. The strides should be balanced and unconstrained.

E. Extended canter

The horse covers as much ground as possible. Without hurrying, the strides are lengthened to the utmost. The horse remains calm, light and straight as a result of great impulsion from the hindquarters. The rider allows the horse to lengthen the frame with a controlled poll and to gain ground. The whole movement should be well-balanced and the transition to collected canter should be smoothly executed by taking more weight on the hindquarters.

F. Gallop

Gallop is an asymmetrical, four-beat gait with a moment of suspension. Footfall sequence during right lead gallop is: left hind leg – right hind leg – left front leg – right front leg – suspension.

When the horse increases the speed in canter it turns into a four-beat gait at some point, then referred to as gallop. Gallop is an extended gait, where the horse lengthens its strides, covering more ground. The horse springs smoothly with engagement and flexion of the loins. The horse lifts the front quarters well off the ground and stretches in a flowing movement, showing good suspension.

The difference between canter and gallop is that during gallop the horse does not hit the ground simultaneously with diagonal legs, but first with the hind leg of the diagonal pair and then with the front leg. During gallop support phases alternate between uni-, bi- and tripod support in a single stride.



G3.2.4 Tölt

The tölt is a symmetrical four-beat gait with lateral sequence of footfalls and eight phases. The footfall sequence is left hind leg - left foreleg - right hind leg - right foreleg. Ideally it should have a regular rhythm with even time interval between ground contacts of each limb, at any speed (that is, a forelimb lands about 1/4 of stride duration after the ipsilateral hind limb). However in slow tölt the stance phase of the hind legs is longer than the stance phase of the front legs.

It is a gait without suspension. However, it has half-suspension, both in front and hind and is therefore considered a running gait. The support phases during the tölt stride alternate between bipedal and unipedal support. The tölt is ridden at various speeds.

Ideal movements in tölt

Characteristic of true tölt is suppleness and fluid movements. The horse should move in balance, with strong and active back and active hind quarters. The movements of the front part are light and free. The horse's rhythm is a pure four-beat rhythm, which runs fluently through the horse.

Faults in tölt

A. Pacey tölt

In tölt it is undesirable if the interval between ground contacts of lateral limbs is too short. Then the correct four-beat rhythm is lost and the tölt resembles pace too much. This is called pacey tölt. Then the tölt is said to have a lateral couplet, which is when the time interval between ground contacts of ipsilateral feet is shorter than 1/4 of the stride duration.

B. Trotty tölt

During tölt it is also undesirable if the interval between ground contacts of diagonal legs is too short. In this case the tölt has lost the purity of the four-beat and the tölt is too close to trot. Then the tölt is said to have a diagonal couplet, that is, when the time interval between ground contacts of lateral feet is longer than 1/4.

C. Stiff tölt

The rhythm is a pure four-beat rhythm but the horse's body lacks suppleness. The back is inactive and stiff and the movements are not flowing through the body of the horse.

D. Irregular beat

It is a fault if the tölt has an irregular beat, for instance is more or less mixed with canter. The movements of the left and right sides of the horse are not symmetrical and there is not an even time interval between ground contact of each four legs.

E. Tripedal support

At a very slow tölt, the half-suspension may disappear at the hind; then the horse supports itself on one front leg and both hind legs simultaneously (tripedal support). In this case the tölt is ridden more slowly than competition and breeding judgment requirements say and the gait is considered an interphase between walk and tölt.

Tölt can be performed as follows:

A. Tölt

The rider should have the riding skills necessary to allow the horse to show a clear beat and energetic tölt. The horse moves forward in an open form with a relaxed the topline and neck. A slack of the rein/loose rein is recognized as long as the rhythm of the tölt is maintained.



B. Slow tölt

The horse moves forward in a slow speed in an even four-beat rhythm, which runs fluently through the horse. The impression should be that the horse could easily tölt a 10 meter circle at that speed. The neck should be arched and the back active and rounded, the whole topline being without tension. The hindquarters are well engaged and the movements of the forequarters are light and free. The horse should move in balance, with a strong and active back.

C. Medium tölt

This is a pace between the slow and the extended tölt. Without hurrying, the horse goes forward with clearly lengthened strides and impulsion from the hindquarters. The rider allows the horse to carry the head and neck more extended, with strong and active back and suppleness. The strides should be balanced and unconstrained.

D. Speed changes

Slow tölt is required on the short sides and on the curves, and medium tölt with a clear lengthening of strides is required on the long sides. The emphasis is on the smoothness of the transitions and sufficient distinction in speed due to the lengthening of the strides. Inharmonious extremes like “kick-starts” and “sliding stops” are not desirable.

E. Collected tölt

The horse, remaining “on the bit”, moves forward with the neck raised and arched. The hind legs being well-engaged, maintain an energetic impulsion, enabling the shoulders to move with greater mobility thus demonstrating self-carriage and an uphill tendency. The horse’s strides are shorter than in the other speed categories, without losing elasticity and cadence.

F. Extended tölt

The horse covers as much ground as possible while moving faster than in medium tölt. Without hurrying, the strides are lengthened to the utmost. The horse remains calm, light and straight as a result of great impulsion from the hindquarters. The rider allows the horse to lengthen the frame with a controlled poll and to gain ground.

G. Fast tölt

The horse should go in an even four-beat rhythm, which runs fluently through the horse. The horse should lengthen its strides and the head and neck becomes more extended than at slow tölt, the whole topline still being strong and without tension. The horse should move with a strong active back, engaged hindquarters and suppleness. The stance phase of front and hind legs becomes more even than at a slow tölt and diagonal bipedal support decreases.

H. Slow to medium tempo without rein contact

This section should show the natural movement without any rein contact from the rider. The horse should be in balance and have natural carriage.

The tempi are described in slow and medium tölt. However the neck and head of the horse can be more extended than when ridden with active rein contact, provided that the horse still moves in balance, with strong and active back, engaged hind quarters, with suppleness and fluid movements.

G3.2.5 Pace**Description**

Pace is a symmetrical, two-beat gait with a moment of suspension, where lateral legs move almost synchronously back and forth. The footfall sequence is left hind - left front - suspension - right hind - right front – suspension. It is one of the front legs that propel the horse into suspension before the diagonal hind leg lands. At high speed in pace the footfalls



of the lateral limbs become dissociated with contact of the hind limb preceding the front limb on the same side. Pace is still considered a two-beat gait since the divergence from synchronous movements of lateral legs is not noticeable.

Ideal movements in pace

Pace should only be executed as flying pace: Secure, effortless, impressive with long strides with good period of suspension and excellent speed.

Pace is an energetic gait ridden at high speed, where the horse lengthens its strides. During pace the horse should lift its back and extend the head and neck forward. In the suspension-phase lateral front and hind legs are stretched far forward and the opposite legs are stretched far backward. Pace is considered pure if the moment of suspension is clearly visible and the divergence from synchronous movements of lateral legs is not noticeable.

Faults in pace

A. Four-beat pace

The so-called four-beat pace is undesirable. Pace is four-beat if the dissociation of lateral limbs becomes visible and time interval between ground contacts of lateral limbs becomes too long. With increased four-beat rhythm the horse's suspension-phase becomes shorter.

B. Stiff pace

It is also undesirable if the pace is stiff and with too much lateral movement. The movement goes too much to the sides of the horse and it is unable to proceed fast enough. If the horse's centre of gravity moves too forwards the front leg hits the ground before the ipsilateral hind leg and the horse switches to disunited canter. This change of gaits is referred to as jumping out of gait.

C. Irregular pace

It is a fault if the pace has an irregular beat and the horse is repeatedly losing its balance and jumping into gallop and then taking the pace again. This is often associated with too high neck-carriage, too much four-beat in the pace and the horse taking a few strides of gallop in between.

G3.3. Certification of origin

It is the responsibility of each FEIF member association to validate the pedigree of all registered Icelandic horses in its country and ensure that only pure-bred Icelandic horses are entered into WorldFengur, the official global register of the Icelandic horses/ Studbook of Origin. FEIF member associations must co-operate with all Icelandic horse studbooks recognised by the statutory bodies in its country. FEIF member associations must also co-operate with horse studbooks recognised by all other FEIF member associations, and those studbooks recognised by its statutory bodies, through international directives and agreements.

A pure-bred Icelandic horse is defined as one whose pedigree can be traced back *only* to Icelandic born horses. The FEIF registration group together with FEIF director of breeding shall make the final decision, in cases where the pedigree is open to question.

A national studbook restricted to Icelandic horses should only allow the entry of horses when these are holding recognised studbook registration papers issued in Iceland, in another FEIF member country, or are able to present documentation (blood-type or DNA analysis), which proves the lineage back to horses registered in a recognised Icelandic horse studbook of a FEIF member association, or in WorldFengur.



G3.4. Official and international Database: WorldFengur FEIF/BÍ

G3.4.1 Nature and purpose of WorldFengur Rules

WorldFengur (worldfengur.com) is the official global register of Icelandic horses/Studbook of Origin. The WorldFengur project of co-operation has been established between FEIF and Bændasamtök Íslands (BÍ). The terms of the co-operation are documented in a co-operation agreement. FEIF member associations may subscribe to WorldFengur by entering into a subscription agreement with BÍ.

WorldFengur is managed by the WorldFengur board made up of one to two members appointed by the board of FEIF, and the breeding leader of Iceland, and the head of the computer department of BÍ. The WorldFengur board is accountable to - BÍ and FEIF.

The chairman of the WorldFengur Board of Co-operation shall prepare a written annual report including a yearly financial statement describing the incomes and expenses of the Project. The report and financial statement is presented first to BÍ for comments and secondly to the annual FEIF meeting of national breeding leaders for final approval.

G3.4.2 International co-operation

Basic registration in WorldFengur of exported horses officially registered in the country of birth is performed free of any charges to any other FEIF member association by the authorised office of the country of birth.

For exported horses without a FEIF ID-number the country of birth shall be requested by the country of residence to allocate the FEIF ID-number and to register the horse in WorldFengur as promptly as possible.

To ensure an easy and prompt international co-operation all FEIF member associations shall name a WorldFengur contact person to be responsible of meeting the above request.

If the country of birth is not a subscriber to WorldFengur, the official registrar or any other office authorised as such by the national FEIF member association in the country of birth shall allocate the FEIF ID-number upon request from another FEIF member association.

Bændasamtök Íslands (BÍ) shall be the only official office authorised to perform Basic registration of a horse born in a non-subscribing country. Such a registration in WorldFengur is only possible upon a request from a subscriber. The data registration fee is to be paid by the FEIF member association of the country of birth.

G3.4.3 Entries in the register

A pedigree registration in the register means that

- The horse is identified by the FEIF International Identification number;
- The horse's pedigree meets the requirements of the FEIF Rules for Registration and Identification of Icelandic Horses and

Entries of any breeding assessment results means that they are achieved at a breeding show organised in accordance with the Icelandic assessment system or the FEIF rules for breeding shows.

G3.4.1.1. Responsibility

Only the Subscriber has the authority to add or change any Data relating to that Subscriber's Section of the database during the period of its subscription. For this purpose Section



means that part of the database relating to horses registered by the subscriber as being located in the subscriber's country.

G3.4.1.2. Use of Information

WorldFengur is accessible to FEIF, BÍ, FEIF member associations, and their members for private use. Applications for research, educational or commercial use must be referred by the subscriber to the WorldFengur board for permission.

G3.4.1.3. Leaving WorldFengur

If a subscriber leaves WorldFengur then BÍ will provide the outgoing subscriber with a copy of the extractable data of all horses born in or registered as living in relation to that country, up to the level of the first Icelandic born ancestor in every branch of the pedigree, so as to assist it to re-establish and continue its studbook, keeping on its own account.

G3.4.1.4. Resolution of Dispute

Any disputes or complaints by individual horse breeders or owners shall be referred to the member country in the first instance. If the member country is unable to resolve the matter, the member country shall refer to the WorldFengur board for resolution or a decision.

Any disputes or complaints by the member country shall be referred to the WorldFengur board. If a member country is dissatisfied with the outcome the matter may be referred to the annual FEIF meeting of national breeding leaders.

G3.5. Registration and identification of the horse

G3.5.1 FEIF International Identification Number (FEIF ID)

All horses registered in a recognised Icelandic horse studbook must have an identification number for the life of the horse, preferably according to the FEIF International Identification Number System (FEIF ID).

This number has international validity and is a unique identification of the horse in the population of all Icelandic horses in the world with the purpose to identify and register the horse in the global database: WorldFengur. The FEIF ID can only be allocated by the FEIF member association in that country.

The FEIF Registration Group together with the FEIF Director of breeding shall be the final arbiter of nation of birth and thus the country code component of the FEIF ID.

The formula for the FEIF International Identification Number System is:

CCYYYSRRRR

The components of the formula are:

CC = Country Code (country of origin) comprising of two letters

AT = Austria	AU = Australia	BE = Belgium
CA = Canada	CZ = Czech Republic	DK = Denmark
FO = Faroe Islands	FI = Finland	FR = France
GB = Great Britain	GL= Greenland	DE = Germany
HU= Hungary	IS = Iceland	IE = Ireland
IT = Italy	LI= Lichtenstein	LU =Luxembourg
NL = Netherlands	LT= Lithuania	NZ= New Zealand



NO = Norway	PL= Poland	PT = Portugal
RO= Romania	RU= Russia	SI = Slovenia
ES= Spain	SE = Sweden	CH = Switzerland
US = United States		

YYYY = Century and year of birth comprising of four figures.

S = Sex comprising of one figure. The codes are as follows:

- 1 = Male horse (colt, stallion or gelding)
- 2 = Female horse (filly or mare)

RRRRR = Unique serial registration number comprising of five figures identifying each specific horse within the country of birth. The system for allocating this number is at the discretion of the FEIF member association in each country.

The following rules apply to the FEIF International Identification Number System:

- a. A FEIF International Identification Number is compulsory for horses (including their lineage back to horses registered in WorldFengur) participating in all international shows.
- b. The FEIF International Identification Number should be used on all official certificates relating to that horse.
- c. Other local/national numbers can be used on certificates, in addition to the FEIF International Identification Number, provided it does not create confusion. The FEIF International Identification Number should be clearly shown as such.
- d. Questions or problems regarding the FEIF International Identification Number should be referred to the Breeding leader of the appropriate FEIF member association. If the Breeding Leader is unable to resolve the matter, it shall be raised to the FEIF Registration Group.
- e. The FEIF-ID number must be registered into WorldFengur within a week of being issued on an official certificate relating to the horse. The FEIF-ID number is not valid until it has been registered into WorldFengur.

G3.5.2 Certificate of Origin / Horse Passport

Recognised studbook offices in the country of birth should issue a printed certificate of Origin/ Horse Passport with at least the following information:

1. Name and origin of the horse (in accordance with Icelandic naming traditions), see rules for naming Icelandic horses in G3.5.6),
2. FEIF International Identification number,
3. Year of birth,
4. Identification markings,
5. Colour and markings,
6. Pedigree certificate - 4 generations or until Icelandic born horses which have no further pedigree information,
7. Name and address of breeder,
8. Date and signature of issuing studbook officer,
9. Official stamp, name and address of the studbook office,

FEIF member associations fulfilling the above demands are allowed to have the FEIF logo printed on the Certificate or the Passport.

A Certificate of Origin from the issuing authority in the country of birth should not be withdrawn or replaced by a studbook office of the new country of residence, after exportation. On registering an imported horse the studbook officer should record that the imported horse



has been registered in the Icelandic horse studbook on the basis of an original certificate issued by a recognised studbook in the country of birth. Any replaced original Certificates of Origin shall be clearly marked with date, stamp and signature that the certificate is only valid when being accompanied by another (referred to by name of issuing authority) official Certificate of Origin.

In the case of the need to make major alterations to a pedigree, a name or the FEIF international identification number - the national studbook office and WorldFengur Office shall observe the following rules:

1. Any alteration has to be authorised by the officer in charge of the national studbook office.
2. A record shall be kept explaining the reason for the alterations and evidence that it is correct.
3. A record shall be kept of previous valid information.
4. Information about such alterations and the reason behind them must be registered in WorldFengur. The new information must be notified to the WorldFengur registrars in the country of location and the country of birth and be sent out to all FEIF member association breeding leaders.

G3.5.3 Breeding program for Icelandic horses

The breeding program aims at preservation and improvement of the Icelandic horse breed. Selection of breeding horses is based on results from the FEIF / Icelandic breeding horse assessment system and estimated breeding values (BLUP) are used to select breeding horses, to realise and to monitor genetic gain in the population of Icelandic horses registered in WorldFengur. Stallions used in breeding that are born in the year 2000 or later shall have proof of parentage by DNA analysis or blood type and those who are born in 2006 or later by DNA analysis. Mare used in breeding should preferably have recorded DNA analysis in WorldFengur. All horses used in the breeding programme must be identified and registered according to the FEIF rules. Stallions and mares that are used in breeding should be free from genetic defects such as bone spavin and defects in reproductive organs.

G3.5.4 Registration of horses born outside Iceland

A horse born outside Iceland can be registered in WorldFengur by the approved national breeding association in the nation state of its birth when:

- The horse is by a stallion and out of a mare, which are both registered in WorldFengur,
- The covering is registered in WorldFengur or complete proof of parentage is available by DNA analysis and
- If the father of the horse is born in the year 2000 or later, then he must have proof of parentage. If he is born 2000-2005 this may be by DNA analysis or blood type. If he is born in 2006 and later this must only be by DNA analysis.

G3.5.5 Registration of imported horses

- The recognized breeding association in a FEIF member nation state can register a horse imported from another FEIF member country in WorldFengur on their account when the original Certificate of Origin and horse passport issued by a studbook in the country of birth is presented to the studbook office.
- All other imported horses can only be registered in WorldFengur when proof of the lineage has been given by blood type or DNA-analysis back to horses born in Iceland.



G3.5.6 The naming of Icelandic horses in WorldFengur

- Horses can be registered in WorldFengur with name and origin. Each horse can have a maximum of two names in combination. Horses must be given names before (and cannot be changed after) they are shown at a breeding show or they compete in an official FEIF competition registered in WorldFengur. The name of a horse cannot be changed after they have a registered offspring in WorldFengur. Horse owners can use the list of horse names in WorldFengur (which includes allowed names) as a reference. If the name they want to use is not in the list, they can apply for it (via the national registrars) and if the name is allowed, it is added to the list. The following rules apply for names of Icelandic horses registered in WorldFengur:
- The names that are registered in WorldFengur shall be in Icelandic and in accordance with Icelandic grammar and spelling. The name shall be masculine for a stallion/gelding and feminine for a mare, neuter names and names consisting entirely of initials are not allowed. Names that have a vulgar or obscene meaning, names considered in poor taste, or names that may be offensive to religious, political or ethnic groups are not allowed. A preposition or grammatical equivalent to the word "from" in the native language shall be used; the Icelandic preposition "frá" and "fra" will also be accepted.

G3.5.7 FEIF guidelines for embryo transfer

- The surrogate mare must be pure-breed Icelandic with FEIF ID and DNA profile
- The parentage of surrogate and donor mare must be verified with DNA.
- The transfer product horse (foal) must be with DNA profile.
- Limitation of offspring per mare in one year:
 - max 2 foals with embryo transfer.
 - one foal (if there are twins – two) naturally carried out by the mother
 - max. 3 (4) offspring's per year.
- A clear sign in WorldFengur should indicate which offspring (s) are from surrogate mare(s)
- Cloned horses or their offspring are not permitted in WF.
- Gene manipulation is not permitted in Icelandic horse breeding.

G3.6. The FEIF WorldFengur registration group

G3.6.1 Terms of reference

The FEIF registration group together with FEIF Director of Breeding will consider all matters concerning the pedigree and certification of pure-bred Icelandic horses.

G3.6.2 Specific Duties

In cases where the pedigree is open to question, the FEIF registration group, together with FEIF Director of Breeding, shall be the final arbiter on a horse being pure-bred, or not.

The FEIF Registration Group together with FEIF Director of breeding shall be the final arbiter of nation of birth and thus the country code component of the FEIF-ID.

The FEIF registration group, together with FEIF Director of Breeding, shall be the final arbiter in any question of the naming of the horse or the farm.



In the pursuit of consistency and high standards, the FEIF registration committee will, provide guidance and assistance in the appropriateness, format and spelling of horse and farm names.

In the pursuit of consistency and high standards, the FEIF registration group will propose registration protocols to be adopted by FEIF member associations, which take due account of international and nation legislation.



G4. Anti-Doping Procedures

The following anti-doping rules represent the minimum standard if no other rules apply. FEIF will only step in if the country has no jurisdiction.

Anti-Doping programmes seek to preserve what is intrinsically valuable about comparison of results of athletes, human or equine. This intrinsic value is often referred to as "the spirit of sport"; it is the essence of Olympism; it is how we play true. The spirit of sport is the celebration of the human spirit, body and mind, and is characterized by the following values in all our shows and events.

- Ethics, fair play and honesty
- Health
- Excellence in performance
- Character and education
- Fun and joy
- Teamwork
- Dedication and commitment
- Respect for Rules and laws
- Respect for self and other participants
- Courage
- Community and solidarity

Doping is fundamentally contrary to the spirit of sport.

- The Equine Anti-Doping Rules (EAD) of FEIF are based upon the Equine Anti-Doping and Controlled Medication Regulations (EADCM Regulations) of FEI. All matters concerning equine doping have to be handled in the spirit of these Rules.
- FEI Controlled Medication Rules (including the Equine Prohibited Substances List and sampling procedures) apply without restriction.
- Member Associations of FEIF have to decide before the first of January of every calendar year if their own authority to handle equine doping cases is sufficient and in accordance with FEI EADCM Regulations, article 13.1. This means full implementation of the Equine Anti-Doping Rules of their national FN (National FEI-member). Failure to decide in due time results in acceptance of the authority of FEIF to handle equine doping cases for the calendar year in question.
- The EAD of FEIF apply to all Sport and Gæðingakeppni competitions and Breeding Events.
- The EAD of FEIF is limited to 'In-competition' testing only, unless national procedures include 'Out-of-Competition' testing.
- The positive outcome of any test has to be reported to FEIF. Any decision taken is valid for all FEIF Member Associations. Failure to report may lead to disciplinary measures against the Member Association involved.

* Doping rules are based on FEI



G4.1. Definition of Doping

Doping is defined as the occurrence of one or more of the EAD Rule violations set forth in the relevant articles of these FEIF EAD Rules.

G4.2. EAD Rule Violations

Owners and riders (Persons Responsible) and/or their grooms and staff (Support Personnel) shall be responsible for knowing what constitutes an EAD Rule violation and the substances and methods which have been included on the Equine Prohibited Substances List and identified as Banned Substances and Banned Methods. Where Banned Substances or Banned Methods are involved, the following constitute EAD Rule violations:

G4.2.1 The presence of a Banned Substance and/or its Metabolites or Markers in a Horse's Sample

G4.2.1.1. It is each Person Responsible's personal duty to ensure that no Banned Substance is present in the Horse's body. Persons Responsible are responsible for any Banned Substance found to be present in their Horse's Samples, even though their Support Personnel will be considered additionally responsible under Articles 4.2.2 – 4.2.8 below where the circumstances so warrant. It is not necessary that intent, fault, negligence or knowing Use be demonstrated in order to establish an EAD Rule violation under Article 4.2.1.

G4.2.1.2. Sufficient proof of an EAD Rule violation under Article 4.2.1 is established by either of the following: (i) presence of a Banned Substance and/or its Metabolites or Markers in the Horse's A-Sample where the Person Responsible waives analysis of the B-Sample and the B-Sample is not analysed; or, (ii) where the Horse's B-Sample is analysed and the analysis of the Horse's B-Sample confirms the presence of the Banned Substance and/or its Metabolites or Markers found in the Horse's A-Sample. An Adverse Analytical Finding may be established by a positive blood or urine Sample.

G4.2.1.3. Excepting those Banned Substances for which a quantitative threshold is specifically identified in the Equine Prohibited Substances List, the presence of any quantity of a Banned Substance and/or its Metabolites or Markers in a Horse's Sample shall constitute an EAD Rule violation.

G4.2.1.4. As an exception to the general rule of Article 4.2.1, the Equine Prohibited Substances List or the FEI Standard for Laboratories may establish special criteria for the evaluation of Banned Substances that can also be produced endogenously.

G4.2.1.5. Use or Attempted Use of a Banned Substance or a Banned Method

G4.2.1.6. It is each Person Responsible's personal duty, along with members of their Support Personnel, to ensure that no Banned Substance enters into the body. Accordingly, it is not necessary that intent, fault, negligence or knowing Use on the part of the Person Responsible, or member of his Support Personnel (where applicable), be demonstrated in order to establish an EAD Rule violation for Use of a Banned Substance or a Banned Method. However, in accordance with the definition of Attempt, it is necessary to show intent in order to establish an EAD Rule violation for Attempted Use of a Banned Substance or a Banned Method.



G4.2.1.7. The success or failure of the Use or Attempted Use of a Banned Substance or a Banned Method is not material. It is sufficient that the Banned Substance or Banned Method was Used or Attempted to be Used for an EAD Rule violation to be committed.

G4.2.1.8. Refusing or failing without compelling justification to submit to Sample collection after Notification (in accordance with the FEI Veterinary Regulations) or to comply with all Sampling procedure requirements including signing the Sampling form or otherwise evading Sample collection.

G4.2.1.9. Tampering, or Attempted Tampering with any part of Doping Control.

G4.2.1.10. Administration or Attempted Administration of a Banned Substance.

G4.2.1.11. Possession of a Banned Substance(s) or a Banned Method(s). This bans the Persons Responsible and members of their Support Personnel from Possessing Banned Substances or Banned Methods, unless he demonstrates compelling justification for the Possession (This section should be read in conjunction with the definition of Possession set forth in Appendix 1 of the FEI EADCM).

G4.2.1.12. Trafficking or Attempted Trafficking in any Banned Substance or Banned Method.

G4.2.1.13. Assisting, encouraging, aiding, abetting, covering up or any other type of complicity involving an EAD Rule violation or any Attempted EAD Rule violation.

G4.3. Proof of EAD Rule Violations

G4.3.1. Burdens and Standards of Proof

FEIF or its Member Association shall have the burden of establishing that an EAD Rule violation has occurred. The standard of proof shall be whether FEIF or its Member Association has established an EAD Rule violation to the comfortable satisfaction of the Hearing Panel bearing in mind the seriousness of the allegation which is made. This standard of proof in all cases is greater than a mere balance of probability but less than proof beyond a reasonable doubt. Where these EAD Rules place the burden of proof upon the Persons Responsible and/or member of their Support Personnel to rebut a presumption or establish specified facts or circumstances, the standard of proof shall be by a balance of probability, except where a different standard of proof is specifically identified.

G4.3.2. Methods of establishing facts and presumption

Facts related to EAD Rule violations may be established by any reliable means, including admissions. The following Rules of proof shall be applicable in Doping cases brought under these EAD Rules:

G4.3.2.1. FEI-approved Laboratories are presumed to have conducted Sample analysis and custodial procedures in accordance with the FEI Standard for Laboratories. The Person Responsible and/or member of the Support Personnel who is alleged to have committed the EAD Rule violation may rebut this presumption by establishing by a balance of probability that a departure from the FEI Standard for Laboratories occurred which could reasonably have caused the Adverse Analytical Finding. If the preceding presumption is rebutted by showing that a departure from the FEI Standard for Laboratories occurred which could reasonably have caused the Adverse Analytical Finding, then the FEIF shall have the burden to establish that such departure did not cause the Adverse Analytical Finding.



G4.3.2.2. Departures from another FEI standard, FEIF Rule or Regulation, FEIF Manual or policy which did not by a balance of probability cause an Adverse Analytical Finding or other EAD Rule violation shall not invalidate such results. If the Person Responsible and/or member of the Support Personnel (where applicable) establishes, by a balance of probability, that a departure from another FEI standard, FEIF Rule or Regulation, FEIF Manual or policy could reasonably have caused the Adverse Analytical Finding or other EAD Rule violation, then the FEIF must prove that the departure did not cause the Adverse Analytical Finding or the factual basis for the EAD Rule violation.

G4.3.2.3. The facts established by a Decision of a court or professional disciplinary tribunal of competent jurisdiction which is not the subject of a pending appeal shall be irrebuttable evidence against the Person Responsible and/or member of the Support Personnel to whom the Decision pertained with regards to the factual findings unless it can be established that the Decision violated principles of natural justice.

G4.3.2.4. The Hearing Panel presiding over a case alleging an EAD Rule violation may draw an inference adverse to the Person Responsible and/or member of the Support Personnel (where applicable) who is asserted to have committed an EAD Rule violation based on the refusal, after a request made in a reasonable time in advance of the hearing, to appear at the hearing (either in person or telephonically as directed by the FEIF Disciplinary Board) in order to answer questions from the Hearing Panel of FEIF.

G4.4. The Equine Prohibited Substances List

G4.4.1. Incorporation of the Equine Prohibited Substances List

These EAD Rules incorporate the Equine Prohibited Substances List (the “List”) which is published and revised by the FEI from time to time. The FEI will publish the current List in such a manner that it is available to its members and constituents, including, but not limited to, publication on the FEI website.

G4.4.2. Review and Publication of Banned Substances and Banned Methods Identified on the List

The FEI may revise the List from time to time but at least once annually by posting the new List on the FEI website, or via such other appropriate channel, but such new List shall not go into effect any sooner than ninety (90) days following its publication.

G4.4.3. Substances and Methods included on the List

The FEI’s categorization of a substance or method on the List as a Banned Substance or Banned Method (in particular, as opposed to a Controlled Medication Substance or Method) including any establishment of a threshold for a Banned Substance and/or the quantitative amount of such threshold shall be final and binding on all parties and shall not be subject to challenge by a Person Responsible, member of the Support Personnel or any other Person on any basis.



G4.5. Testing

G4.5.1. Authority to Test

All horses registered present, presented or competing at a breeding show, sport event or Gæðingakeppni event shall be subject to In-Competition Testing (a) by FEIF in case of an event organized under the jurisdiction of FEIF (b) in other cases by the National Member Association where the event takes place, or (c) by any other Anti-Doping Organisation responsible for Testing at an Event.

G4.5.2. Responsibility for FEIF testing

The FEIF Director of the relevant department (Breeding or Sport) shall be responsible for overseeing all Testing conducted by FEIF. Testing may be conducted by the Testing Veterinarians or by other qualified and authorised persons at a given Event or at such other place as authorised by these EAD Rules, the FEI Veterinary Regulations, or as authorised in writing by the Board of FEIF or his or her designee(s).

G4.5.3. Testing Standards

Testing conducted by or on behalf of FEIF shall be in substantial conformity with the Testing procedures set forth in the FEI Veterinary Regulations in effect at the time of Testing.

G4.5.4. Selection of Horses to be tested

G4.5.4.1. FEIF shall determine the number of Tests to be performed and on which Horses they shall be performed.

G4.5.4.2. In addition to the selection procedures set forth in Articles 4.5.4.1 above, the responsible FEIF Official may also select Horses for Random Testing and/or Target Testing in cooperation with the Chief Judge.

G4.5.4.3. Each National Member Association shall determine, within its jurisdiction, the number of Tests to be performed and on which Horses they shall be performed.

G4.5.4.4. Nothing in these EAD Rules shall be construed to limit where FEIF is authorised to conduct Testing on Horses In- Competition.

G4.6. Analysis of Samples

Samples collected under these EAD Rules and arising from FEI Testing are the property of FEIF. They shall be analysed in accordance with the following principles:

G4.6.1. Use of Approved Laboratories

These EAD Rules incorporate the FEI List of Approved Laboratories which is published and revised by the FEI from time to time. FEIF shall send Samples for analysis only to these approved Laboratories, which are subject to the FEI Standard for Laboratories. The choice of Laboratory used for the Sample analysis of either or both the A and B-Sample shall be determined exclusively by FEIF. However, the Person Responsible may elect to have the B-Sample analysed at a different Laboratory than the one which performed the A-Sample analysis. If such an election is made, FEIF shall select the B-Sample Laboratory from the FEI List of Approved Laboratories and inform the Person Responsible accordingly.



G4.6.2. Purpose of Collection and Analysis of Samples

Samples shall be analysed to detect Banned Substances and Banned Methods, all as set forth in the List. FEIF may also seek to detect other substances for research and monitoring purposes, as publicly announced by the FEI from time to time pursuant to a defined monitoring programme.

G4.6.3. Research on Samples

No Sample may be used for any purpose other than as described in Article 4.6.2 above, without the Person Responsible's written consent. Those Samples used for purposes other than as set forth in Article 4.6.2 (for example research) following written consent from the Person Responsible shall have all means of identification removed from the Sample so it cannot be traced back to a particular Horse or Person Responsible. All Samples shall be destroyed pursuant to the guidelines set forth in the FEI Standard for Laboratories and in no event later than the lapse of the Statute Of Limitations in Article 4.14 below.

G4.6.4. Standards for Sample Analysis and Reporting

Laboratories shall analyse Samples and report results in conformity with the FEI Standard for Laboratories.

G4.6.5. Retesting Samples

A-Sample may be reanalysed for the purpose of Article 4.6.2 above at any time exclusively at the direction of FEIF. The circumstances and conditions for retesting Samples shall conform with the requirements of the FEI Standard for Laboratories. The retesting of Samples may lead to an EAD Rule violation only if the Sample was taken at World Championships and only if the Banned Substance or Banned Method was prohibited at the time the Sample was taken, all subject to Article 4.14.

G4.7. Results Management

G4.7.1. Results Management for Tests arising out of FEIF Testing or other EAD Rule violations

Results management for Tests arising out of FEIF Testing or other EAD Rule violations shall proceed as set forth below:

G4.7.1.1. The results of all Sample analyses must be sent exclusively to FEIF, in a report signed by an authorised representative of the Laboratory. All communications must be conducted in such a way that the results of the Sample analyses are confidential.

G4.7.1.2. Upon receipt of an A-Sample Adverse Analytical Finding, FEIF shall conduct a review to determine whether there is any apparent departure from Testing procedures of the FEI Veterinary Regulations, the FEI Standard for Laboratories or another FEI standard, FEI Rule or Regulation, FEI Manual or policy that caused the Adverse Analytical Finding.

G4.7.1.3. If the initial review under Article 4.7.1.2 does not reveal an apparent departure from the Testing procedures of the FEI Veterinary Regulations, the FEI Standard for Laboratories or another FEI standard, FEI Rule or Regulation, FEI Manual or policy that



caused the Adverse Analytical Finding, FEIF shall promptly Notify the Person Responsible and the Owner of the Horse (if applicable) and the relevant Member Association* of:

- a. the Adverse Analytical Finding;
- b. the EAD Rule violated;
- c. the Person Responsible's and the Owner of the Horse's (if applicable) right to promptly request the analysis of the B-Sample, or, failing such request, that the B-Sample analysis may be deemed waived;
- d. the opportunity for the Person Responsible and the Owner of the Horse (if applicable) to elect to have the B-Sample analysed at a different laboratory than the one which performed the A-Sample analysis, such Laboratory to be chosen by FEIF, and the opportunity to send a representative (witness) to be present for the B-Sample analysis within the time period specified in the FEI Standard for Laboratories unless allowing such representative or witness presents a threat to the integrity of the analysis process; and
- e. the right of the Person Responsible and the Owner of the Horse (if applicable) to request copies of the A and B-Sample (if applicable) Laboratory Documentation Package which includes information as specified in the FEI Standard for Laboratories.
- f. If, upon the initial review, FEIF decides not to bring forward the Adverse Analytical Finding as an EAD Rule violation, it shall so notify the Person Responsible's Member Association.

G4.7.1.4. Pursuant to Article 4.7.1.3 (d) above, within seven (7) days of receipt of the duly executed Confirmatory Analysis Request Form (B-Sample), FEIF will propose possible dates for such analysis. The Person Responsible and the Owner of the Horse (if applicable) may accept the A-Sample analytical results by waiving the right to a B-Sample analysis. FEIF may nonetheless elect at its discretion to proceed with the B-Sample analysis. In such case, the B-Sample analysis shall only be used to confirm the A-Sample Adverse Analytical Finding. The Person Responsible and the Owner of the Horse (if applicable) is deemed to have waived his right to a B-Sample analysis if he does not submit the Confirmatory Analysis Request Form within the stipulated time-limit in the Notification.

G4.7.1.5. In addition to the Person Responsible and the Owner of the Horse (if applicable) and his/their representative (witness), a representative of the National Member Association(s) involved as well as a representative of FEIF shall also be allowed to be present for the B-Sample analysis. If Notice under Article 7.1.3 has not been carried out through the National Member Association, the National Member Association shall be informed in a timely manner by FEIF of the Adverse Analytical Finding and its right to attend the B-Sample analysis.

G4.7.1.6. If the B-Sample proves negative, then the entire test shall be considered negative. FEIF shall be informed of the results confidentially and shall notify the Person Responsible and the Owner of the Horse (if applicable).

G4.7.1.7. If a Banned Substance or the Use of a Banned Method is identified in the B-Sample, FEIF shall be informed of the results confidentially and shall notify the Person Responsible and the Owner of the Horse (if applicable).

G4.7.1.8. FEIF may conduct any follow-up investigation as may be required. Upon completion of such follow-up investigation, if any, FEIF shall promptly notify the Person Responsible's National Member Association of the results of the follow-up investigation.



G4.7.1.9. For the avoidance of doubt, an Adverse Analytical Finding confirmed by the B-Sample analysis may result from blood or urine Samples, or any combination thereof (for example, a confirmatory B-Sample analysis is valid if performed on a blood sample, even if the A-Sample Adverse Analytical Finding arose from a urine Test, and vice-versa). In addition, and also for the avoidance of doubt, where the A-Sample is positive for a Threshold Banned Substance, as it is quantitatively above the threshold level set for the Banned Substance, the B-Sample shall be deemed to confirm the A-Sample so long as the level of the B-Sample is also quantitatively above the threshold, even if the B-Sample level varies quantitatively from the A-Sample level.

G4.7.1.10. Where appropriate, the members of the Support Personnel, including the Owner, shall receive Notification of the EAD Rule violation and all relevant corresponding documents.

G4.7.2. Review of Atypical Findings

In some circumstances Laboratories are directed to report the presence of Banned Substances, which may also be produced endogenously, as Atypical Findings subject to further investigation. Upon receipt of an A-Sample Atypical Finding, FEIF shall conduct a review to determine whether there is any apparent departure from the Testing procedures, the FEI Standard for Laboratories or another FEI standard, FEI Rule or Regulation, FEI Manual or policy that caused the Atypical Finding. If that review does not reveal any departure that caused the Atypical Finding, FEIF shall conduct the required investigation. After the investigation is completed, the Person Responsible, and the Owner of the Horse (if applicable) and his or her National Member Association, shall be Notified whether or not the Atypical Finding will be brought forward as an Adverse Analytical Finding. The Person Responsible's National Member Association shall be notified as provided in Article 4.7.1 EAD Rules.

G4.7.2.1. FEIF will not provide Notice of an Atypical Finding until the investigation is completed and it has decided whether it will bring the Atypical Finding forward as an Adverse Analytical Finding. However, if FEIF determines that the B-Sample should be analysed prior to the conclusion of the investigation under Article 4.7.2, FEIF may conduct the B-Sample analysis after supplying the Person Responsible and the Owner of the Horse (if applicable) with such Notice including a description of the Atypical Finding and the information described in Article 4.7.1.3 (b)-(e) above.

G4.7.3. Review of Other EAD Rule Violations

For apparent EAD Rule violations that do not involve Adverse Analytical Findings, FEIF may conduct any necessary follow-up investigation and at such time as FEIF is satisfied that an EAD Rule violation has occurred, it shall then promptly notify the Person Responsible, the Owner of the Horse (if applicable) and/or member of the Support Personnel (where applicable) of the EAD Rule which appears to have been violated and basis of the violation.

G4.7.4. Provisional Suspensions

G4.7.4.1. FEIF shall provisionally suspend a Person Responsible, member of the Support Personnel, and/or the Person Responsible's Horse prior to the opportunity for a full hearing based on: (a) an admission that an EAD Rule violation has taken place (for the avoidance of doubt, an admission by any Person can only be used to provisionally suspend that Person); or (b) all of the following elements: (i) an Adverse Analytical Finding from the A-Sample or A and B-Samples; (ii) the review described in Article 4.7.1.2 above; and (iii) the Notification described in Article 4.7.1.3 above.



G4.7.4.2. FEIF may provisionally suspend a Person Responsible, member of the Support Personnel, and/or the Person Responsible's Horse prior to the opportunity for a full hearing based on evidence that a violation of these EAD Rules is highly likely to have been committed by the respective Person.

G4.7.4.3. If a Provisional Suspension is imposed by FEIF, either the hearing in accordance with Article 8 below shall be advanced to a date which avoids substantial prejudice to the Person alleged to have committed the EAD Rule violation, or such Person shall be given an opportunity for a Preliminary Hearing either on a timely basis after imposition of Provisional Suspension or before imposition of the Provisional Suspension in order to show cause why the Provisional Suspension should not be imposed (or should be lifted). Where a Horse is provisionally suspended, the Owner shall also have the right to request a Preliminary Hearing.

G4.7.4.4. The Provisional Suspension shall be maintained unless the Person requesting the lifting of the Provisional Suspension establishes to the comfortable satisfaction of the FEIF Disciplinary Board that:

G4.7.4.5. (i) the allegation that an EAD Rule violation has been committed has no reasonable prospect of being upheld, e.g., because of a material defect in the evidence on which the allegation is based; or

G4.7.4.6. (ii) the Person can demonstrate that the evidence will show that he bears No Fault or No Negligence for the EAD Rule violation that is alleged to have been committed, so that any period of Ineligibility that might otherwise be imposed for such offence is likely to be completely eliminated by application of Article 4.10.4.1 below or that 4.10.4.2 applies and the Person can demonstrate that the evidence will show that he bears No Significant Fault or Negligence and that he has already been provisionally suspended for a period of time that warrants the lifting of the Provisional Suspension pending a final Decision of the FEIF Disciplinary Board; or

G4.7.4.7. (iii) exceptional circumstances exist that make it clearly unfair, taking into account all of the circumstances of the case, to impose a Provisional Suspension prior to the final hearing of the FEIF Disciplinary Board. This ground is to be construed narrowly, and applied only in truly exceptional circumstances. For example, the fact that the Provisional Suspension would prevent the Person or Horse competing in a particular Event shall not qualify as exceptional circumstances for these purposes.

G4.7.4.8. If a Provisional Suspension is imposed based on an A-Sample Adverse Analytical Finding and a subsequent B-Sample analysis (if requested) does not confirm the A-Sample analysis, then the Person(s) alleged to have committed the EAD Rule violation and his member of the Support Personnel, and/or Horse shall not be subject to any further Provisional Suspension on account of a violation of Article 4.2.1 above (Presence of a Banned Substance or its Metabolites or Markers). In circumstances where the Person Responsible or his Horse has been removed from an Event based on a violation of Article 2.1 and the subsequent B-Sample analysis does not confirm the A-Sample finding, if it is still possible for the Person Responsible and his Horse to be re-entered without otherwise affecting the Event, the Person Responsible and his Horse may continue to take part in the Event.

G4.7.4.9. After the imposition of a Provisional Suspension and following a Preliminary Hearing but prior to a final hearing, the Person Responsible and/or member of the Support Personnel (including Owner) can petition the FEIF Disciplinary Board for another Preliminary Hearing provided that new evidence exists that, if known at the time of the earlier Preliminary Hearing, may have satisfied the requirements of Article 4.7.4.2 above and may have led to



the lifting of the Provisional Suspension. Such petition must be made in writing to the FEIF Disciplinary Board and copied to the responsible official appointed by the Board of FEIF and must clearly establish the existence of such new evidence meeting this criterion. If the request for another Preliminary Hearing is granted by the FEIF Disciplinary Board, the same FEIF Disciplinary Board member who presided over the prior Preliminary Hearing will decide the new Preliminary Hearing request, unless exceptional circumstances prevent it from doing so, in which case another FEIF Disciplinary Board member will be appointed to conduct the new Preliminary Hearing. If another Preliminary Hearing is granted after the Hearing Panel has been constituted, any member of the Hearing Panel may conduct the Preliminary Hearing. Preliminary Hearing Decisions may be issued by the FEIF Disciplinary Board without reasons.

G4.7.4.10. During a period of Provisional Suspension, no Person Responsible and/or member of the Support Personnel who themselves are provisionally suspended, or a Horse that is provisionally suspended, may participate in any capacity at an Event, or activity, or be present at an Event (other than as a spectator) that is authorised or organised by FEIF or any National Member Association or in Events authorised or organised by any international or national level Event organisation.

G4.7.5. Retirement from Sport

If a Person Responsible and/or member of the Support Personnel retires while a Results Management process is underway, FEIF retains jurisdiction to complete its Results Management process. If a Person Responsible and/or member of the Support Personnel retires before any Results Management process has begun, FEIF similarly has jurisdiction to conduct Results Management.

G4.8. Right to a Fair Hearing

G4.8.1. Hearings before the FEIF Disciplinary Board

G4.8.1.1. The FEIF Disciplinary Board shall decide all cases involving violations of these EAD Rules.

G4.8.1.2. When it appears, following the Results Management Process described in Article 4.7 above, that these EAD Rules have been violated, then the case shall be submitted to a Hearing Panel of the FEIF Disciplinary Board for adjudication.

G4.8.1.3. Hearings pursuant to this Article shall be completed expeditiously following the completion of the Results Management or investigation process described in Article 4.7 above and the submission of all relevant evidence and pleadings by the parties. The Person Responsible and/or member of the Support Personnel (where applicable) alleged to have violated the EAD Rules shall cooperate promptly in the submission of such evidence and pleadings and in attendance at a hearing if requested by the FEIF Disciplinary Board.

G4.8.1.4. The Person Responsible and/or member of the Support Personnel (including Owner) alleged to have violated the EAD Rules may attend the hearing under all circumstances.

G4.8.1.5. A Person Responsible and/or member of the Support Personnel (where applicable) may acknowledge the EAD Rule violation and accept consequences consistent with Articles 4.9 and 4.10 below as proposed by FEIF.



G4.8.1.6. Decisions of the FEIF Disciplinary Board may be appealed to the FEIF Arbitration Council as provided in the Statutes of FEIF.

G4.8.2. Principles for a Fair Hearing

All Decisions and hearings under these EAD Rules shall respect the following principles:

- fair and impartial Hearing Panel;
- the right to be represented by counsel (separately or together) at the Person Responsible's and/or member of the Support Personnel's (including Owner's) own expense;
- The right to be fairly and timely informed of the asserted EAD Rule violation;
- The right to respond to the asserted EAD Rule violation and resulting consequences;
- The right of each party to present evidence;
- The right of each party to call and question witnesses (subject to the Hearing Panel's discretion to accept testimony by telephone or written submission);
- A timely hearing, subject to prompt and complete submissions by the parties;
- The Person Responsible's and/or member of the Support Personnel's (including Owner) right to an interpreter at the hearing if requested at least five (5) business days in advance of the hearing, with the Hearing Panel to determine the identity and responsibility for the costs of the interpreter; and
- A timely, written, reasoned decision, specifically including an explanation for any period of Ineligibility.

G4.8.3. Waiver of Hearing

The right to a hearing may be waived either expressly or by the Person Responsible's and/or member of the Support Personnel's (where applicable) failure to request a hearing within ten (10) days of Notification that such a violation is alleged. Where no hearing occurs, the FEIF Disciplinary Board shall issue a reasoned decision.

G4.9. Automatic Disqualification of Individual Results

A violation of these EAD Rules in connection with a test in a given Event automatically leads to the Disqualification of the result of the Person Responsible and Horse combination obtained in that Event with all resulting Consequences, including forfeiture of any related medals, points and prizes. Even if a Sanction is reduced or eliminated under Article 4.10 below, such reduction or elimination shall under no circumstances reverse the automatic Disqualification of Individual Results mandated by this Article 4.9.

G4.10. Sanctions

G4.10.1. Disqualification of Results in the Event during which an EAD Rule Violation Occurs

The following Rules relating to the Disqualification of results will apply:

G4.10.1.1. At Events organized under the jurisdiction of FEIF: An EAD Rule violation occurring during or in connection with an Event shall lead to Disqualification of all of the Person Responsible's individual results obtained in that Event, with any and all Horses with which the Person Responsible competed, with all consequences, including forfeiture of all medals, points and prizes, except as provided in Article 4.110.1.4.



G4.10.1.2. At Events other than those listed above: an EAD Rule violation occurring during or in connection with an Event may lead to Disqualification of all of the Person Responsible's individual results obtained in that Event, with any and all Horses with which the Person Responsible competed, with all consequences, including forfeiture of all medals, points and prizes, except as provided in Article 4.10.1.4. Where applicable, consequences to teams will take place as provided in Article 4.11).

G4.10.1.3. Notwithstanding the above, for all Events, including but not limited to Events organized under the jurisdiction of FEIF, exceptional circumstances may be considered. Generally, and subject to 4.10.1.4 and 4.10.1.5 below, all Results from Competitions in which the Person Responsible or Horse participated prior to Sample collection shall be disqualified unless it can be demonstrated that such Results were not likely to have been affected by the EAD Rule violation.

G4.10.1.4. If the Person Responsible establishes that he bears No Fault or Negligence for the EAD Rule violation, the Person Responsible's individual results in the other Competitions shall not be Disqualified unless the Person Responsible's results in Competitions other than the Competition in which the EAD Rule violation occurred were likely to have been affected by the Person Responsible's EAD Rule violation.

G4.10.1.5. In addition, the Person Responsible's Horse may also be Disqualified from the entire Event with all Consequences, including forfeiture of all medals, points, and prizes even if earned while being ridden by someone other than the Person Responsible, if the Horse's results in Competitions other than the Competition in which the EAD Rule violation occurred were likely to have been affected by the EAD Rule violation.

G4.10.2. Ineligibility and Fine for Presence, Use or Attempted Use or Possession of Banned Substances and Banned Methods

G4.10.2.1. The Sanction imposed for a violation of Article 4.2.1 (presence of a Banned Substance or its Metabolites or Markers), Article 4.2.2 (Use or Attempted Use of a Banned Substance or a Banned Method) or Article 4.2.6 (Possession of a Banned Substance or a Banned Method) shall be as follows unless the conditions for eliminating, reducing, or increasing the Sanction provided in 4.10.4 or 4.10.5 are met.

G4.10.2.2. First Violation: Two (2) years Ineligibility; a Fine of CHF 15,000 unless fairness dictates otherwise, and appropriate legal costs.

G4.10.2.3. Multiple Violations: As set forth in Article 4.10.6 below.

G4.10.2.4. Ineligibility for Other Rule Violations

G4.10.2.5. The Sanction for EAD Rule violations other than as provided in Articles 4.9, 4.10.1 and 4.10.2 above shall be as follows:



G4.10.2.6. For violations of Article 4.2.3 (Refusing or Failing without compelling justification to Submit to Sample collection or to comply with all Sampling procedure requirements including signing the Sampling form or otherwise evading Sample collection), Article 4.2.4 (Tampering or Attempted Tampering with any part of Doping Control), Article 4.2.5 (Administration or Attempted Administration of a Banned Substance), Article 4.2.6 (Possession of Banned Substances or Banned Methods) or Article 4.2.8 (Assisting, encouraging, aiding, abetting, covering up or any other type of complicity involving an EAD Rule violation or any Attempted EAD Rule violation.) the Sanction shall be as set forth in Articles 4.9 and 4.10.2 above, unless the conditions for eliminating, reducing or increasing the Sanction provided in Articles 4.10.4 or 4.10.5 are met.

G4.10.2.7. For violations of Article 4.2.7 (Trafficking or Attempted Trafficking), the period of Ineligibility imposed shall be a minimum of four (4) years up to lifetime Ineligibility unless the conditions provided in Article 4.10.4 are met. A Fine of CHF 25,000 shall also be imposed, unless fairness dictates otherwise, along with appropriate legal costs. In addition, significant violations of Articles 4.2.7 or 4.2.8 which may also violate non-sporting laws and regulations shall be reported to the competent administrative, professional or judicial authorities.

G4.10.3. Elimination or Reduction of Period of Ineligibility Based on Exceptional Circumstances

G4.10.3.1. No Fault or Negligence

If the Person Responsible and/or member of the Support Personnel (where applicable) establishes in an individual case that he bears No Fault or Negligence for the EAD Rule violation, the otherwise applicable period of Ineligibility and other Sanctions (apart from Article 4.9) may be eliminated in regard to such Person. When a Banned Substance or its Metabolites or Markers is detected in a Horse's Sample in violation of Article 4.2.1 (presence of a Banned Substance), the Person Responsible and/or member of the Support Personnel (where applicable) must also establish how the Banned Substance entered the Horse's system in order to have the period of Ineligibility and other Sanctions eliminated. In the event this Article is applied and the period of Ineligibility otherwise applicable is eliminated, the EAD Rule violation shall not be considered a violation for the limited purpose of determining the period of Ineligibility for multiple violations under Article 4.10.6 below.

G4.10.3.2. No Significant Fault or Negligence

If a Person Responsible and/or member of the Support Personnel (where applicable) establishes in an individual case that he bears No Significant Fault or Negligence, then the otherwise applicable period of Ineligibility and other Sanctions (apart from Article 4.9) may be reduced in regard to such Person, but the reduced period of Ineligibility may not be less than one-half of the period of Ineligibility otherwise applicable. If the otherwise applicable period of Ineligibility is a lifetime, the reduced period under this Article may be no less than eight (8) years. When a Banned Substance or its Metabolites or Markers is detected in a Horse's Sample in violation of Article 4.2.1 (presence of a Banned Substance or its Metabolites or Markers), the Person alleged to have committed the EAD Rule violation must also establish how the Banned Substance or its Metabolites or Markers entered the Horse's system in order to have the period of Ineligibility reduced.

G4.10.3.3. Substantial Assistance in Discovering or Establishing EAD Rule Violations

The FEIF Disciplinary Board may, prior to a final appellate Decision under Article 4.12 below or the expiration of the time to appeal, suspend a part or all of the period of Ineligibility imposed in an individual case where the Person Responsible and/or member of the Support Personnel has provided Substantial Assistance to FEIF, criminal authority or professional disciplinary body which results in FEIF discovering or establishing an EAD Rule violation by another Person or which results in a criminal or disciplinary body discovering or establishing



a criminal offence or the breach of professional Rules by another Person. Such Substantial Assistance must be independently corroborated in order to reduce the period of Ineligibility and under no circumstance should it amount only to blaming another Person or entity for the alleged EAD Rule violation. The extent to which the otherwise applicable period of Ineligibility may be suspended shall be based on the seriousness of the EAD Rule violation committed and the significance of the Substantial Assistance provided in an effort to promote drug-free equestrian sport. In any event, no more than three-quarters of the otherwise applicable period of Ineligibility may be suspended. If the otherwise applicable period of Ineligibility is a lifetime, the non-suspended period under this section must be no less than eight (8) years. If the FEIF Disciplinary Board subsequently reinstates any part of the suspended period of Ineligibility because the Person Responsible and/or member of the Support Personnel has failed to provide the Substantial Assistance which was anticipated, the Person Responsible and/or member of the Support Personnel may appeal the reinstatement pursuant to Article 4.12.2.

G4.10.3.4. Admission of an EAD Rule Violation in the Absence of Other Evidence: Where a Person Responsible and/or member of the Support Personnel voluntarily admits the commission of an EAD Rule violation before having received Notice of a Sample collection which could establish an EAD Rule violation (or, in case of an EAD Rule violation other than Article 4.2.1, before receiving first Notice of the admitted violation pursuant to Article 4.7) and that admission is the only reliable evidence of the violation at the time of admission, then the period of Ineligibility may be reduced, but not below one half of the period of Ineligibility otherwise applicable.

G4.10.3.5. Where a Person Responsible and/or member of the Support Personnel Establishes Entitlement to a Reduction in Sanction Under More than One Provision of this Article: If the Person Responsible and/or member of the Support Personnel establishes entitlement to a reduction or suspension of the period of Ineligibility under two (2) or more of Articles 4.10.4.2, 4.10.4.3 and 4.10.4.4, then the period of Ineligibility may be reduced or suspended, but not below one quarter of the otherwise applicable period of Ineligibility.

G4.10.4. Aggravating Circumstances Which May Increase the Period of Ineligibility

If FEIF establishes in an individual case involving an EAD Rule violation other than violations under Article 2.7 (Trafficking or Attempted Trafficking) that aggravating circumstances are present which justify the imposition of a period of Ineligibility greater than the standard sanction, then the period of Ineligibility otherwise applicable shall be increased up to a maximum of four (4) years unless the Person Responsible and/or member of the Support Personnel can prove to the comfortable satisfaction of the Hearing Panel that he did not knowingly commit the EAD Rule violation. The Person Responsible and/or member of the Support Personnel can avoid the application of this Article by admitting the EAD Rule violation as asserted promptly after being confronted by FEIF with the EAD Rule violation.

G4.10.5. Multiple Violations

G4.10.5.1. Second EAD Rule Violation following an EAD Rule and/or ECM Rule Violation For the Person Responsible's and/or member of the Support Personnel's first EAD Rule violation, the period of Ineligibility is set forth in Articles 4.10.2 and 4.10.3 (subject to elimination, reduction, or suspension under Article 4.10.4 or to an increase under Article 4.10.5). For a second EAD Rule violation, the period of Ineligibility shall be increased by the Hearing Panel, taking into account the respective severity of both EAD Rule violations involved and the circumstances of the particular case. The period of Ineligibility shall be a minimum of eight (8) years up to a lifetime Ineligibility if, alternatively, (i) both EAD Rule



violations were or should be sanctioned by the standard sanction of two (2) years under Articles 4.10.2 or 4.10.3.1, or (ii) at least one of the two EAD Rule violations was or should be sanctioned by an aggravated Sanction under Article 4.10.5 or by a Sanction under Article 4.10.3.2. In all other cases, the Ineligibility period shall be within the range of one (1) year to eight (8) years.

Where a Person Responsible and/or member of the Support Personnel is found to have committed an EAD Rule violation after having committed an ECM Rule violation, this may be considered as a factor in determining aggravating circumstances under Article 4.10.5 above.

G4.10.5.2. Application of Articles 4.10.4.3 and 4.10.4.4 to Second EAD Rule Violation
Where a Person Responsible and/or member of the Support Personnel who commits a second EAD Rule violation establishes entitlement to suspension or reduction of a portion of the period of Ineligibility under Article 4.10.4.3 or Article 4.10.4.4 above, the Hearing Panel shall first determine the otherwise applicable period of Ineligibility and then apply the appropriate suspension or reduction of the period of Ineligibility. The remaining period of Ineligibility, after applying any suspension or reduction under Articles 4.10.4.3 and 4.10.4.4 above, must be at least one-fourth of the otherwise applicable period of Ineligibility.

G4.10.5.3. Third EAD Rule Violation following two EAD Rule Violations, two ECM Rule Violations or an EAD Rule and an ECM Rule Violation

A third EAD Rule violation will always result in a lifetime period of Ineligibility, except if the third violation fulfils the condition for elimination or reduction of the period of Ineligibility under Article 4.10.4. In these particular cases, the period of Ineligibility shall be from eight (8) years to a lifetime period of Ineligibility.

Where a Person Responsible and/or member of the Support Personnel is found to have committed an EAD Rule violation after having committed

- a) an EAD Rule violation and an ECM Rule violation or
- b) two ECM Rule violations,

this will be considered as a factor in determining aggravating circumstances under Article 4.10.5 above.

G4.10.5.4. Additional EAD Rules for certain Potential Multiple Violations

For purposes of imposing sanctions under Article 4.10.6, an EAD Rule violation will only be considered a further violation if FEIF can establish that the Person Responsible and/or member of the Support Personnel (where applicable) committed the prior violation after he received Notice of the earlier violation pursuant to Article 4.7 (Results Management), or after FEIF made reasonable efforts to give Notice of the earlier violation.

If FEIF cannot establish this, the violations shall be considered together as one single first violation, and the Sanction imposed shall be based on the violation that carries the more severe sanction. However, the occurrence of multiple violations may be considered as a factor in determining aggravating circumstances under Article 4.10.5.

If, after the resolution of a first EAD Rule violation, FEIF discovers facts involving an EAD Rule violation by the Person Responsible and/or member of the Support Personnel which occurred prior to Notification regarding the first violation, then the FEIF Disciplinary Board shall impose an additional Sanction based on the Sanction that could have been imposed if the further violations would have been adjudicated at the same time. Results in all Competitions dating back to the earlier EAD Rule violation will be disqualified as provided in Article 4.9 and 4.10.1. To avoid the possibility of a finding of aggravating circumstances (Article 4.10.5) on account of the earlier-in-time but later-discovered violation, the Person Responsible and/or member of the Support Personnel must voluntarily admit the earlier EAD Rule violation on a timely basis after Notice of the violation for which he or she is first charged. The same rule shall also apply when FEIF discovers facts involving another prior violation after the resolution of a second EAD Rule violation.



G4.10.5.5. Multiple EAD Rule and/or ECM Rule Violations During an Eight-Year Period For purposes of Article 10.6, each EAD Rule/ECM Rule violation must take place within the same eight (8) year period in order to be considered multiple violations or to be considered as aggravating circumstance.

G4.10.5.6. Violations involving both a Controlled Medication Substance or Method and a Banned Substance or Method
Where a Person Responsible and/or member of the Support Personnel based on the same factual circumstances is found to have committed a violation involving both (a) Controlled Medication Substance(s) or (a) Controlled Medication Method(s) under the ECM Rules and (a) Banned Substance(s) or (a) Banned Method(s) under these EAD Rules, the Person Responsible and/or member of the Support Personnel shall be considered to have committed one EAD Rule violation and the Sanction imposed shall be based on the Banned Substance or Banned Method that carries the most severe Sanction. The occurrence of multiple substances or methods may be considered as a factor in determining aggravating circumstances under Article 4.10.5 above.

G4.10.6. Disqualification of Results in Competitions Subsequent to Sample Collection or Commission of an EAD Rule Violation

In addition to the automatic Disqualification of the results in the Event/the Competition which produced the positive Sample under Article G4.9 (Automatic Disqualification of Results), all other competitive results obtained from the date a positive Sample was collected, or other EAD Rule violation occurred, through the commencement of any Provisional Suspension or Ineligibility period, shall, unless fairness requires otherwise, be Disqualified with all of the resulting consequences including forfeiture of any medals, points and prizes.

G4.10.6.1. As a condition of regaining eligibility after being found to have committed an EAD Rule violation, the Person Responsible and/or member of the Support Personnel must first repay all prize money forfeited under this Article and any other fines and/or costs attributed to the violation which have been ordered by the FEIF Disciplinary Board or otherwise accepted by the Person Responsible.

G4.10.7. Commencement of Ineligibility Period

Except as provided below, the period of Ineligibility imposed on any Person or Horse shall start on the date of the Decision providing for Ineligibility or any other date specified by the FEIF Disciplinary Board in its decision.

G4.10.7.1. Delays Not Attributable to the Person Responsible or member of the Support Personnel: Where there have been substantial delays in the hearing process or other aspects of Doping Control not attributable to the Person Responsible and/or member of the Support Personnel alleged to have committed the EAD Rule violation, the Hearing Panel may start the period of Ineligibility at an earlier date commencing as early as the date of Sample collection or the date on which another EAD Rule violation last occurred.

G4.10.7.2. Timely Admission: Where the Person Responsible and/or member of the Support Personnel (where applicable) promptly (which, for the Person Responsible, in all circumstances, means before the Person Responsible competes again) admits the EAD Rule violation after being confronted with the EAD Rule violation by FEIF, the period of Ineligibility may start as early as the date of Sample collection or the date on which another EAD Rule violation last occurred. In each case however where this Article is applied, the Person who committed the EAD Rule violation shall serve at least one-half of the period of Ineligibility going forward from the date Ineligibility is imposed or accepted.



G4.10.7.3. If a Provisional Suspension is imposed and respected by the Person Responsible and/or member of the Support Personnel, or Horse, then a credit shall be received for such period of Provisional Suspension against any period of Ineligibility which may ultimately be imposed as determined by the Disciplinary Board.

G4.10.7.4. If a Person Responsible and/or member of the Support Personnel voluntarily accepts a Provisional Suspension in writing for himself, herself or the Horse, and thereafter refrains from participating in equestrian activities, such Person or Horse shall receive a credit for such period of voluntary Provisional Suspension against any period of Ineligibility which may ultimately be imposed. A copy of the voluntary Provisional Suspension shall be provided promptly to each party entitled to receive Notice of a potential EAD Rule violation. If a Provisional Suspension is voluntarily accepted, it can only be lifted by Decision of the FEIF Disciplinary Board.

G4.10.7.5. No credit against a period of Ineligibility shall be given for any time period before the effective date of the Provisional Suspension or voluntary Provisional Suspension regardless of whether the Person alleged to have committed the EAD Rule violation elected not to compete or was suspended by his team.

G4.10.8. Status During Ineligibility

G4.10.8.1. Prohibition Against Participation during Ineligibility

No Horse, Person Responsible and/or member of the Support Personnel who has been declared Ineligible may, during the period of Ineligibility, participate in any capacity at an Event, or in a Competition or activity that is authorised or organised by FEIF or any National Member Association or be present at an Event (other than as a spectator) that is authorised or organised by FEIF or any National Member Association, or participate in any capacity at an Event authorised or organised by any international or national-level Event organisation. In addition, for any EAD Rule violation, some or all of sport related financial support or other sport-related benefits received by such Person Responsible and/or Support Personnel may be withheld by FEIF and/or its National Member Associations. A Horse subject to a period of Ineligibility shall remain subject to Testing. In addition, any Person Responsible and/or member of the Support Personnel or Horse subject to Ineligibility under Article 10 may also be banned from any venues where FEI competitions are taking place, whether or not the Person Responsible or member of the Support Personnel is registered with FEIF.

G4.10.8.2. Violation of the Prohibition of Participation During Ineligibility

Where a Person Responsible and/or member of the Support Personnel who has been declared Ineligible or whose Horse has been declared Ineligible violates the prohibition against participation or attendance during Ineligibility described in Article 4.10.9.1 above, the results of any such participation shall be Disqualified and the period of Ineligibility which was originally imposed shall start over so that the entire period of Ineligibility must be served again from the beginning as of the date of the last violation committed. The new period of Ineligibility may be reduced under Article 4.10.4.2 above if the Person Responsible and/or member of the Support Personnel establish that he bears No Significant Fault or Negligence for violating the prohibition against participation or attendance. In addition, further sanctions may be imposed if appropriate. The determination of whether any Person has violated the prohibition against participation or attendance, and whether a reduction under Article 4.10.4.2 above or any other sanctions are appropriate, shall be made by the FEIF Disciplinary Board.



G4.11. Consequences to Teams

- a) If a member of a team is found to have committed a violation of these EAD Rules during an Event where a team ranking is based on the addition of individual results, the results of the Person Responsible may be Disqualified in all Competitions and will be subtracted from the team result, to be replaced with the results of the next applicable team member. If by removing the Person Responsible's results from the team results, the number of Athletes counting for the team is less than the required number, the team shall be eliminated from the ranking.
- b) Notwithstanding the above, for all Events, exceptional circumstances may be considered.

G4.12. Appeals

G4.12.1. Decisions Subject to Appeal

Decisions made under these EAD Rules may be appealed as set forth below in Article 4.12.2 through 4.12.3. Such Decisions shall remain in effect while under appeal unless the appellate body orders otherwise.

G4.12.2. Appeals from Decisions Regarding EAD Rule Violations, Consequences, and Provisional Suspensions

The following Decisions may be appealed exclusively as provided in this Article 4.12.2

- a Decision that an EAD Rule violation was committed;
- a Decision imposing consequences for an EAD Rule violation;
- a Decision that no EAD Rule violation was committed;
- a Decision that an EAD Rule violation proceeding cannot go forward for procedural reasons (including, for example, exceeding the Statute of Limitations);
- a Decision under Article 4.10.9.2 (Violation of the Prohibition of Participation during Ineligibility);
- a Decision that FEIF or a National Member Association lacks jurisdiction to rule on an alleged EAD Rule violation or its consequences;
- a Decision by any National Member Association not to bring forward an Adverse Analytical Finding or an Atypical Finding as an anti-doping violation, or a Decision not to go forward with an anti-doping violation; and
- a Decision to impose a Provisional Suspension as a result of a Preliminary Hearing or otherwise, in violation of Article 4.7.4; the only Person that may appeal from a Provisional Suspension is FEIF or the Person upon whom or upon whose Horse the Provisional Suspension is imposed.

G4.12.2.1. In all cases arising the Decision may be appealed exclusively to the FEIF Arbitration Council in accordance with the provisions applicable before the FEIF Arbitration Council.

G4.12.2.2. In cases under Article 4.12.2.1, the following parties shall have the right to appeal to the FEIF Arbitration Council:

- (a) the Person Responsible and/or member of the Support Personnel who is the subject of the Decision being appealed, or the Horse Owner, where its Horse is subject to Provisional Suspension or Ineligibility;



- (b) the other party to the case in which the Decision was rendered;
- (c) FEIF;
- (d) the National Member Association of the Person who is the subject of the Decision being appealed; and
- (e) the International Olympic Committee or International Paralympic Committee, as applicable, where the Decision may have an effect in relation to the Olympic Games or Paralympic Games, including Decisions affecting eligibility for the Olympic Games or Paralympic Games.

G4.12.3. Time for Filing Appeals

The time to file an appeal to the FEIF Arbitration Council shall be thirty (30) days from the date of Receipt of the Hearing Panel Decision by the appealing party. The above notwithstanding, the following shall apply in connection with appeals filed by a party entitled to appeal but which was not a party to the proceedings having led to the Decision subject to appeal:

- a) Within ten (10) days from Notice of the Decision, such party/ies shall have the right to request from the Hearing Panel having issued the Decision a copy of the file on which it relied; a failure to make such request shall however not preclude such party from appealing to the FEIF Arbitration Council within the time period set forth above; and
- b) If such a request is made within the ten (10) day period, then the party making such request shall have thirty (30) days from receipt of the file to appeal to the FEIF Arbitration Council.

G4.13. Application, Reporting and Recognition

G4.13.1. Application of FEIF EAD Rules

When National Equine Anti-Doping Rules apply, they shall specifically incorporate Articles 4.2, 3, 4, and 4.8.2 of these EAD Rules into their anti-doping regulations and enforce them against their members, unless doing so would contravene any applicable national law. With regards to the other Articles of these EAD Rules, National Member Associations, to the extent they do not wish to incorporate them, shall adopt corresponding provisions which embody similar concepts and principles, especially with respect to Article G4.10.

G4.13.2. Statistical Reporting

National Member Associations shall report to FEIF at the end of every year aggregated and anonymous results of all Doping Controls within their jurisdiction. FEIF may periodically publish Testing data received from National Member Associations as well as comparable data from Testing under FEIF's jurisdiction.

G4.13.3. Public Disclosure

G4.13.3.1. Neither FEIF or its National Member Association shall publicly identify Horses or Persons Responsible whose Horses' Samples have resulted in Adverse Analytical Findings, or Persons Responsible and/or members of the Support Personnel who were alleged to have otherwise violated these Rules, until the earlier of completion of the administrative review and Notification described in the respective articles above or the start of the Provisional Suspension of the Person alleged to have violated the EAD Rule.



G4.13.3.2. Once a violation of these EAD Rules has been established, it shall be publicly reported in an expeditious manner via the FEIF website at the discretion of FEIF.

G4.13.3.3. If the Person Responsible and/or member of the Support Personnel or the National Member Association of any such Person makes information concerning an EAD Rule violation or alleged EAD Rule violation public prior to release of this information on the Case Status Table, FEIF may comment on such public information or otherwise publicly report the matter.

G4.13.3.4. In any case where it is determined, after a hearing or appeal, that the Person Responsible and/or member of the Support Personnel did not commit an EAD Rule violation, the Decision may be disclosed publicly only with the consent of the Person who is the subject of the Decision. FEIF shall use reasonable efforts to obtain such consent, and if consent is obtained, shall publicly disclose the Decision in its entirety or in such redacted form as such Person and FEIF may jointly approve.

G4.13.3.5. Neither FEIF, any National Member Association, any FEI approved Laboratory, or any official of any of the above, shall publicly comment on the specific facts of a pending case (as opposed to a general description of process and science), except in response to public comments attributed to the Person Responsible and/or member of the Support Personnel or their representatives.

G4.13.4. Recognition of Decisions by National Member Associations

Any Decision of FEIF regarding a violation of these EAD Rules shall be recognised and enforced by all National Member Associations (including with respect to National Events) and National Member Associations shall take all necessary action to implement any and all ramifications relating to such Decisions. Failure to do so may be considered a violation of these EAD Rules and FEIF Statutes.

G4.14. Statute of Limitations

No action may be commenced under these EAD Rules against a Person Responsible and/or member of the Support Personnel for an EAD Rule violation unless such action is commenced within eight (8) years from the date the violation is asserted to have occurred.

G4.15. Amendment and Interpretation of EAD Rules

G4.15.1.1. These EAD Rules may be amended from time to time by FEIF in accordance with the relevant Rules and Regulations of FEI

G4.15.1.2. Except as provided in Article G4.15.5, these EAD Rules shall be interpreted as an independent and autonomous text and not by reference to existing law or statutes. Nothing herein shall be interpreted to supplant the applicability of national laws to national events.

G4.15.1.3. The headings used for the various parts and Articles of these EAD Rules are for convenience only and shall not be deemed part of the substance of these EAD Rules or to affect in any way the language of the provisions to which they refer.

G4.15.1.4. The Introduction, Appendix 1 Definitions, the Equine Prohibited Substances List, and FEI List of Approved Laboratories, shall all be considered integral parts of these EAD Rules.



G4.15.1.5. These EAD Rules have been adopted pursuant to the FEIF Statutes and General Regulations and shall be interpreted, where applicable, in a manner that is consistent with applicable provisions of these Statutes and General Regulations as well as other FEIF Rules and Regulations including but not limited to the Veterinary Regulations, the Internal Regulations of the FEIF Disciplinary Board, the Procedural Rules of the FEIF Disciplinary Board, the FEI Standard for Laboratories and the various FEIF Rules. In the event of conflict with the Statutes or the General Regulations, the Statutes and the General Regulations shall apply, subject however, to the application by the FEIF Disciplinary Board of the legal principle of *lex specialis derogat legi generali* which provides that a specific provision should govern over a general provision. In the event of conflict with any other Rules or Regulations, these EAD Rules shall apply.

G4.15.1.6. The time limits fixed under the present EAD Rules shall begin from the day after which Notification by FEIF is received. Official holidays and non-working days are included in the calculation of time limits. The time limits fixed under the present EAD Rules are respected if the communications by the parties are sent before midnight on the last day on which such time limits expire. If the last day of the time limit is an official holiday or a non-business day in the country where the Notification has been made, the time limit shall expire at the end of the first subsequent business day.



G5. Events

G5.1. FEIF events – general explanation

FEIF Events are events that are approved by the Board of FEIF, organized in accordance with the current Rules of FEIF, open for a wide international audience, and meeting high standards in terms of quality, organization and horse welfare. FEIF Events give participants a high quality experience. The FEIF logo must be prominently displayed at a FEIF Event, and in all promotional information used for the event.

Absolutely required

- FEIF logo with reference to the FEIF web site in all communication
- Following FEIF rules whenever applicable
- (Also) Information in English, both before and at the event
- Explicit information for foreign audience, with recognisable information about identifiable riders and their performance

Where appropriate:

- Entrance check on all horses involved in accordance to our veterinary Rules
- Fit-to-compete check
- Exit checks on horses leaving the track
- Doping checks on 10% of the horses, in accordance with FEIF Rules
- All officials should adhere the Code of Ethics

An “international” competition being one in which extra-national titles are awarded on in which national teams competed against one another. Examples of such events include the World Championships, the Nordic Championships, and the Mid-European Championships.

G5.2. World Championships

The goal of the World Championships is to organize a large-scale event, which gives people an opportunity to enjoy the Icelandic horse culture and lifestyle. This means to organize World Championships where horse welfare comes first and we connect Icelandic horse culture, lifestyle, enjoyment and passion with the local atmosphere. An event that promotes and improves the recognition of the pure bred Icelandic horse. All actions concerning World Championships need to be in line not only with the letter of the Rules, but also with the spirit of this goal.

The World Championships for Icelandic horses are organized every second year in the name of FEIF, preferably in the beginning of August. World Championships include sport competitions and a breeding show, run according to the applicable sport and breeding Rules.



G5.3. Other Icelandic horse events

G5.3.1. Mid European Championships

Countries eligible to participate in the Mid-European Championships are Austria, Belgium, Germany, Great Britain, France, Italy, Luxembourg, the Netherlands, Slovenia and Switzerland. The event is organized every second year under the responsibility of the Mid-European committee and the organizer, being selected by the committee upon application by the countries willing to organize it and under approval of the countries eligible to participate. Every country may send a certain number of participants. The intention of the event is to offer high class sports event for individual riders and national teams following FEIF's Rules and Regulations. The eligible countries decide every two years about the tests and the age classes.

G5.3.2. Nordic Championships

Countries eligible to participate in the Nordic Championships are the Nordic countries Iceland, Finland, Sweden, Norway, Denmark, and Faroe Islands. The event is organized every second year under the responsibility of the responsible country. The right to apply as organizer for the Nordic Championships is defined (Finland – Sweden – Denmark – Norway). The Nordic Championships follow FEIF's Rules and Regulations and offer a high class sport event for individual riders. The tests are the same as at the World Championships and are judged for senior and junior classes.

G5.3.3. WorldRanking event

The FEIF WorldRanking is a system to compare results of riders of pure-bred Icelandic horses at selected sport events all over the world with each other. FEIF started the WorldRanking in 1995. It is a continuous system: every day a new ranking list is computed. The riders' position in the ranking lists may vary per day. Riders can check what events do count for the FEIF WorldRanking and what marks they did get at any WorldRanking event.

Any FEIF member association may organise WorldRanking events. FEIF grants WorldRanking status to events following an application available from and described on the FEIF website. WorldRanking events are conducted following FEIF's Rules and Regulations including the provisions of the World Ranking Addendum (Sport Rules and Regulations). Additional national or local tests may be offered at WorldRanking events. These tests are not defined in FEIF's Sport Rules but should be conducted following the General Rules.

G5.3.4. FEIF breeding show

In breeding shows, horses should first be judged for conformation, (after they have been measured) and after that for riding abilities. When all horses in the show have been judged there is a second ridden assessment in which all horses judged for riding abilities may participate. In breeding shows that last a whole week or longer it is allowed to arrange the second ridden assessment over more than one day.



G6. World Championships - Approved Information

World Championships are organised in the name of FEIF and FEIF is thus responsible for the way in which they are carried out. The board of FEIF sets these rules. It will not be possible to have a World Championship in non-European member countries.

The Organising Committee (OC) is responsible for the practical organisation of the event and decides on the date, place and programme.

Each fully paid up member country can participate at the World Championships.

G6.1. General

1. The Board of FEIF decides 4 years in advance which country will host the World Championships. The Board of FEIF may enter into an agreement with a third-party to organise the World Championships if no member association is willing to take on the task.
2. The OC must set up a secretariat that is able to handle all enquiries in English and which will assist with problems associated with participation and attendance at the World Championships.
3. The chairman of the OC must be selected and his name made public at least one year in advance.
4. FEIF maintains two documents to be followed during the World Championships: *Rules and Regulations for World Championships Organizers* and the *World Championships Manual*. The *Manual* represents the collected experience from all past World Championships. The most recent manual, updated following the most recent World Championships, is expressly incorporated into any and all agreements for the current World Championships.
5. The OC should submit a written report on the competition to the FEIF board within three months after the World Championships are held.
6. The World Championships are carried out in accordance with the FEIF Rules and Regulations in force.
7. The competition grounds and tracks must comply with the FEIF Rules and should be prepared one year before the World Championship.
8. Local security Rules should be met, to be proven with a security plan approved by local authorities in due time.
9. The competition grounds should be easy to reach by both private transport (car) and public transport.
10. The OC will take care of all necessary contracts and agreements to allow the practical execution of the arrangement and will be responsible for its finances.
11. When videos are made of World Championships, the organisers shall ensure that FEIF is entitled to use the basic tapes after a certain time has elapsed. This means that FEIF is able to use parts of the videos to produce educational videos.
12. The FEIF logo must be included in the World Championships logo.
13. Any agreements between FEIF and the organiser must be confirmed in writing.



G6.2. Allocation of responsibilities

1. The FEIF Director of Sport is responsible for the correct management of the sport side of the Championships. He must approve the tracks, the time schedule and the individual events and make certain that the World Championships are carried out according to the Rules and in the fair and friendly spirit of FEIF.
2. The FEIF Director of Breeding is responsible for the correct management of the breeding side of the championships.
3. The Board of FEIF selects a Competition Leader who is responsible for the practical direction of the championship and must see that the programme is kept to time, that any additional shows are correctly presented and that all necessary information is given correctly and in good time.
4. The FEIF Director of Sport and FEIF Director of Breeding respectively will decide over matters that do not fall under the jurisdiction of the arbitration committee.
5. The FEIF board will decide over matters of association policies or matters involving problems of ethics or principles.

G6.3. Finances

1. The participants will pay no starting fees.
2. The participating countries will not have to pay for their horses' hay, grazing, straw and water. The organisers have the right to charge for the use of boxes and stables.
3. The organiser must either pass 10 % of the entrance fee on to FEIF, with a minimum of € 65.000 indexed according to the rate of inflation as reported by the European Central Bank^{*} from the date the agreement is signed to the date of final payment. Alternatively, the host may come to an agreement with FEIF at least 3 years before the start of the World Championships where the fee can be based upon any combination of a fixed amount or a fixed amount combined with a share in the total turnover or profit or a certain number of free tickets with VIP-access for guests invited by FEIF. However the expected outcome should be comparable to the amount remitted in comparable situations. This payment shall be remitted by September 30 just after the World Championship at the latest. A certified accountant should approve the final accounting.
4. The costs of travelling and lodging will be shared between the organizer and participating countries. The organizer contributes € 20.000 (indexed for inflation according to the same procedure as the basic FEIF fee), the rest will be contributed by the participating countries, based upon the number of members per team. The costs of travel and lodging for the required meeting of the judges are included in this expense.
5. In case requirements are not met and FEIF has extra costs (like for extra inspections), those costs are fully accountable to the OC.
6. In case the OC fails to meet the requirements after a warning the board of FEIF is allowed to fine the host organisation with a maximum fee of 10% of the expected license fee per event. This fee is not refundable.

^{*} http://www.ecb.europa.eu/stats/prices/indic/forecast/html/table_hist_hicp.en.html



7. Each participating country has the right to free entrance passes for all riders and one groom per horse. Reserve riders* are not entitled to free entrance passes. In addition, team officials (1-2 team leader(s) sport; 1 team leader breeding; and 1 trainer) shall receive free passes.
8. World Championship judges will receive free passes.
9. Board members and honorary members of FEIF will receive free passes. FEIF also gets free passes for those persons who do necessary work during the World Championship
10. Additional free passes for the press, invited guests etc. may be issued at the discretion of the organisers.

G6.4. Information

1. The organisers are responsible for supplying the participants with all relevant information in at least the FEIF language, English.
2. Sufficient notice boards must be available to inform not only the participants but other interested parties about changes to the programme, special events, results etc. These notice boards should also be in the centre of the competition ground and close to the tracks.
3. The speaker service should preferably be in three languages to accommodate the international audience, i.e. English, German and the national language or possibly Icelandic.

G6.5. Sport competitions and breeding shows

1. The following conditions have to be met:
 - a. the sport competitions and the breeding shows shall take place on tracks as described in FEIF's Rules and Regulations.
 - b. in addition to the described tracks, the organiser must provide proper facilities for warming up, a collecting ring, and easy access to collecting ring and tracks.
 - c. in addition to the described tracks, the organiser must provide also proper facilities for the measurement of breeding horses, shoeing check and veterinary inspections.
 - d. sufficient ring stewards should be available for:
 - inspection of equipment (preferably judges)
 - helping the speaker to keep the starting order and the time schedule
 - supplying the speaker with information about rein and sequence of gaits ridden in finals
 - informing the riders about the progress of the current test or breeding show
 - e. an appropriate space near to the oval track for the inspection of equipment must be available.
 - f. an appropriate loudspeaker system must be available; information through the loudspeaker system should also be available in the warming up area, collecting ring and preferably also in the riders' camp and stables.

* Reserve riders are determined after the formal teams are entered following the fit-to-compete checks.

† Sport teams with more than 7 riders including adults, young riders, and defending World Champions are entitled to a Deputy Team leader with the same rights as the Sport Team Leader.



- g. every judge and his secretary must be provided with a chair and a table, and must be sheltered from sun and rain.
 - h. the same facilities shall be provided near to the tracks for the Chief Judge and the FEIF Director of Sport or the FEIF Director of Breeding.
 - i. adequate facilities for the speaker and the data centre is required.
 - j. a sufficient communication system must be available to connect the Chief Judge, head judge of the test, FEIF Director of Sport or FEIF Director of Breeding, Competition Leader speaker, data centre, ring stewards and secretariat.
 - k. sufficient accommodation for the spectators is required.
2. The sport competitions and breeding shows will be carried out according to the FEIF Rules and Regulations.
 3. The year before the World Championships a sport competition approved by FEIF should take place at the competition grounds, on which occasion the FEIF Director of Sport and the FEIF Director of Breeding or their deputies will inspect and approve the grounds.
 4. The breeding horses should be presented to the audience at times where there are sufficient spectators.

G6.6. Secretariat

1. An information service should be available at least one year before the start of the World Championships, including an address, telephone and telefax numbers and preferably an e-mail address.
2. The secretariat should provide proper services for participants, team leaders, officials, press and spectators.
3. Official entry forms, and forms used during the World Championships for shoeing, equipment, information for the speaker, withdrawals, etc. shall be provided by FEIF.
4. The programme must contain a list of all participating horses and their pedigrees. Horses without a proven pure-breed pedigree are not allowed to participate in the World Championship, and the pedigree must be confirmed through WorldFengur.
5. Riders, judges, team leaders, press and the FEIF board members have the right to receive a free copy of the programme including starting lists.
6. The list of results must be completed and available one hour at the latest after the close of the World Championships and shall be distributed via the FEIF website.

G6.7. Service for officials

1. Throughout the World Championships, officials are entitled to free meals. (The additional evening arrangements are not included in this offer.)
2. The officials shall be offered free camping and free parking.
3. A meeting room for the judges just near the track; this room or another room to be used to change clothes and to have common meals.
4. A secretary for the judges to make minutes of meetings if requested by the judges.



G6.8. Horses

1. The participating horses must be kept in accommodation, which can be adequately partitioned by country or in separate paddocks. Horses arriving directly from Iceland must be kept in a separate stable that has been disinfected. The OC will pay for all costs of this special arrangement.
2. Current FEI Veterinary Regulations for stabling apply as far as applicable. These Rules include the availability of a treating veterinarian, qualified farrier, stabling Rules, 24-hour security system, and limited admission to the stabling area. Spectators should not have access to the stables.
3. There should be provision for keeping horses outside (grass, sand or earth corrals) permanent, minimum 5 x 5m per horse.
4. It must be possible to drive horse trailers close to the stables and to the pad-docks. Parking places for trailers and cars close to the stables.
5. No barbed wire fences may be used.
6. Facilities for having at least one person per country sleeping in the vicinity of the horses must be provided.
7. There should be arrangements for a 24-hour security in the stables.
8. Each horse has the right to a sufficient portion of good hay per day plus sufficient fresh water.
9. Participating riders have to comply with the veterinary Rules for their horses set by FEIF and the organising country.
10. The stables shall be located away from unnecessary disturbance, e.g. evening discos.
11. Training possibilities with paddock, oval track, lunging place and ideally areas for riding in the fields or forest.
12. Facilities should be available in full service until the day after the last day of the World Championships

G6.9. Riders

1. Riders' camp has to have a minimum space 100m² / team.
2. Sufficient toilets, showers and parking facilities in the area where the riders' camp is.
3. All local laws about security and fire Rules must be followed.
4. Access to the riders' camp should be limited.
5. Facilities should be available until the day after the last day of the World Championships

G6.10. Team Registration

The member countries shall enter their teams (riders and horses) and team leaders in accordance with the official invitation and on the prescribed forms. Four weeks before the first day of the World Championships the number of horses must be declared to the World Championship organisers.

Two weeks before the first day of the World Championships the FEIF-member countries declare to the World Championship organisers the riders and horses that are most likely to participate at the World Championships. The declaration will include full pedigrees of horses and all other necessary facts.



G6.10.1. Late Registration Fee

FEIF is allowed to charge a fee, equivalent to the fee for protest, from countries that register teams the World Championships after the published closing date. The fee will be charged for every day after the close of entries as announced in the invitation. The same fee shall be charged to countries' teams, which cause extra work for the World Championships secretariat by making out their entries incorrectly.

G6.11. Ceremonies

1. The national flags of all participating countries as well as the FEIF flag must be flown during the World Championships. The flags may be raised as part of a special ceremony, the opening ceremony, or without ceremony.
2. The official opening ceremony shall include presentation of, and be based on, participants, team leaders and judges. The length of the ceremony should respect riders and horses.
3. The official closing ceremony shall include presentation of, and be based on, participants, team leaders and judges. The length of the ceremony should respect riders and horses.

G6.12. Social arrangements

1. The OC should organise on the first day of the World Championships a friendly get-together restricted to teams, team leaders and officials.
2. Each invitation for social events during the official World Championships days must clearly specify for whom the arrangement is intended and who is financially responsible.
3. If special dress or any team presentation is required, this must be announced in the invitation.

G6.13. Prizes

1. The FEIF logo must be included on the medals.
2. Each participating horse will receive a ribbon in the colours of the organising country, printed with the place and year of the World Championship, to be paid for by the organisers.
3. Each rider, team leader and official will receive a memento, to be paid for by the organisers.
4. Medals and rosettes that are not awarded shall be destroyed.
5. At the World Championships prizes in money or goods are not allowed.
6. The mementos, medals and ribbons may not be sold to the general public.
7. The "Gunnar Bjarnasson Perpetual Trophy" shall be awarded by FEIF* to the organiser of the respective World Championships.

* The Board of FEIF is responsible for the perpetual and miniature versions.



G6.13.1. Breeding

The horse achieving the first place in its class shall receive a special prize, horses in places 2-5 receive a ribbon. If more than one horse ties for any place in a class the horse with the highest score calculated to three decimal places shall be awarded 1st place. If the horses still tie, the horse with the higher score for riding abilities is awarded the higher place.

Breeding horses do not receive the title of “World Champion”

G6.13.2. Sport

1. The first three riders in all disciplines receive a medal (1 gold, 1 silver, 1 bronze). All participants in A and B finals will receive a token, indicating their achievement.
2. The top 10 adult and top 5 young riders in each test will receive rosettes for the places 1-5 in colours indicating the places. Adult riders in places 6-10 will receive rosettes in the same colour.
3. The top 10 adult riders in the four-gait and five-gait combinations will be recognized. The top 5 young riders in both combinations will also be recognised.
4. No medals will be distributed for preliminary rounds or introductory disciplines.
5. Medals that are not awarded shall be destroyed.
6. At the World Championships prizes in money or goods are not allowed.
7. The mementos, medals and ribbons may not be sold to the general public. The following perpetual trophies have been donated, miniatures shall be provided as follows:

	ADULT Trophy miniature provided by	YOUTH Trophy miniature provided by
Combination: Five Gait	FEIF	FEIF
Combination: Four Gait	FEIF	FEIF
FEIF Feather Prize	FEIF	
FEIF Breeding trophy	FEIF	
FEIF Team Trophy	FEIF	
Tölt T1	IS	SE
Tölt T2	NO	DE
Four-gait V1	DK	IS
Five-gait F1	AT	GB
Pace race P1	CH	FIN
Pace test PP1	DE	FO
SpeedPass P2	US	FR

The perpetual trophy is to be handed over to the winner with a miniature edition that may be retained. The donating country should supply and pay for the miniature edition.

G6.13.3. Presentation of prizes

1. The presentation of prizes will be shared between members of the OC, FEIF board members and presidents of national associations. .
2. Additionally, the organisers may, after consultation with the FEIF board, let honorary guests or other officials present the prizes.
3. The National Anthems of the winners' countries shall be played when the trophies are presented.



G6.14. Advertisements

1. Advertisements are allowed around the oval track and alongside the pace track under the following conditions:
 - the advertisements have to be on boards which must be placed at least 3 m away from the edge of the oval-track and 5 m away from the edge of the pace-track.
 - the total height from the ground of the advertising board must not be more than 100 cm.
2. The following aspects should be considered in the design of the advertising boards:
 - they should not disturb the horses and/or their riders.
 - they should not block the view of the spectators.
 - they may not be made from materials which cause a visual or auditory nuisance.
 - boards should as far as possible be of similar shape and size.
3. No advertisements are allowed within the confines of the oval track or around the edge of the dressage arena.
4. Judges, photographers and officials may not bear advertisements when working within the confines of the tracks, during the competitions.
5. Advertising on horse and rider is only allowed on:
 - a. 200 cm² on each side of the saddle cloth;
 - b. 80 cm² only once on jackets or top garments at the height of breast;
 - c. 16 cm² on both sides of the shirt collar.
6. Advertising is allowed on starting numbers supplied by the organiser if approved by the FEIF Director of Sport.
7. Company names and/or brand names may not be used in the name of the competition.
8. Manufacturer's markings on equipment, used within the confines of the tracks by the organisers, are allowed if they don't serve an advertising purpose. However, each letter used may not be larger than 15 cm (height and width) and the diameter of logos and/or trademarks may not be more than 45 cm.
9. The organisers may inform the spectators about any relevant sponsorship in breaks and at the beginning and at the end of every discipline.
10. In the case of disagreements, caused by ambiguous interpretation of these Rules, the verdict of the FEIF board is final and binding.
11. Riders who violate these Rules will be disqualified from the World Championships.
12. Organisers who violate these Rules will be disciplined by FEIF. They will be expected to pay a fine to FEIF, which is equivalent to the estimated advertising value gained by the violation. The FEIF board will convene an ad-hoc committee to estimate the amount.

G6.15. Veterinary rules

At World Championships all horses participating must be examined and declared fit by the official veterinary surgeon, preferably the day before the start of the first test or assessment and not earlier than the second to last day before. The event has officially begun for horse and rider when they have been given permission to start.

G6.16. Doping

At World Championships the FEIF Director of Sport, or the FEIF Director of Breeding or the competition leader respectively, draw lots to decide which horses will have samples for analysis taken, before the start of the competitions and breeding show.



GENERAL RULES



G7. Eligibility of horses

G7.1. Appearance of the horse

The Icelandic horse is a unique breed with special qualities. It shall be shown respect unreservedly. The following Rules apply at all times: the natural appearance (e.g. natural growth and colour of hair) of the horse shall not be changed. Exceptions the mane and tail may be trimmed if too long and the horse may be clipped for health and welfare reasons. Hair on the muzzle, fetlocks, and inside the ears shall not be clipped. The rider shall take into account the special background and needs of the Icelandic horse, and keep the horse under as natural conditions as possible, which provide enough light, fresh air and space for free exercise.

G7.2. Handling and training of the horse:

Artificial or psychological methods to alter the natural expression of the horse are not allowed.

The training of the horse shall not include the use of mechanical equipment in order to influence movement and shape. Exceptions: the use of equipment that is generally accepted as normal and used in a way, which is generally accepted. Use of extreme weights or elastic ropes on the legs is forbidden.

Infringement of the above Rules shall be dealt with in accordance with the Rules on disciplinary measures. In cases of doubt or disagreement, the ruling of the FEIF arbitration council is final.

G7.3. The age of a horse

The January of the year of birth is valid for the age of the horse.

G7.3.1. Participating horses in breeding shows

- All horses presented at breeding shows should be well prepared, sound and fit, well fed and well turned out. Artificial methods to alter the natural expression of the horse are not allowed. If the horse is judged for riding abilities it must be at least 4 year old in the calendar year.
- All horses presented at breeding shows need to be registered in the WorldFengur database and individually marked (micro-chipped). The show staff is responsible for reading the marking and comparing it to the registration information on the horse.
- All stallions presented for judgement must have proof of parentage either by blood type or DNA analysis. All stallions presented for judgement and are born from the year 2006 must have a proof of parentage by DNA analysis on both the father and the mother.
- All mares and geldings presented for assessment must have DNA analysis registered in WorldFengur.
- The control/measurement of testicles shall be made by the responsible person, appointed by the show manager, and under responsibility of the judge panel. The measures for statistical reasons can be taken by one person, who is trained for the whole procedure. The measurement of testicles is described in B11.1.4.



G7.3.2. Participating horses in sport events

Purebred Icelandic horses aged five years and above are eligible. Proof is required in the form of the pedigree or a corresponding national certificate. Proof can be required in the form of a passport, or a corresponding certificate.

For World Championships and other international competitions, horses must be at least 6 years old.

The number of tests per horse per day is limited as follows:

- a. a 5 year-old horse, may start twice per day, not including races or cross-country (however, pace test, speed pace and pace races are permitted),
- b. a 6 year-old horse may start 3 times per day,
- c. a 7 year and older horse, may start 4 times per day,
- d. any preliminary round or final is considered to be a start,
- e. for pace test, speed pace, pace race 250m and 150m, 2 runs on one day are counted as 1 start.

It is up to the organisers to check the age of the horse. If a rider disregards this rule, and finishes an additional test, the rider should be eliminated from the test.

G7.4. Doping

FEIF follows FEI rules* regarding the implementation of the Doping Regulations, for the full text valid for FEIF see chapter “4. Anti-Doping Procedures” of this document and the respective paragraphs of the FEIF Statutes. Changes of the Doping Regulations are done on Board decision after consultation with the sport and breeding departments.

In case of differences or changes the most recent version of FEI applies.

* www.fei.org



G8. Tack

Saddle and bridles should suit the Icelandic horse. The following Rules apply to everywhere on the show ground for competitions and breeding events, and last for the entire duration of the competition.

G8.1. Saddles

In principle any sort of saddle or saddle pad, which is suitable for the Icelandic horse, is allowed. Permissible equipment also includes saddle cloths, front girths, cruppers and saddle supports.

G8.2. Bits and bridles

Equipment which is listed on the FEIF website under “Prohibited equipment/Breeding” and “Prohibited equipment/Sport” is not allowed.

G8.2.1. Breeding

Bridles and nosebands

- The bridle and noseband should fit well, be properly adjusted and not harm the horse.

Bits

- The bit should fit the horse and not hurt its mouth.
- The judges can allow bitless bridles if there is good reason for it.

G8.2.2. Sport

Any bit may be used as part of a bridle provided it

- is suitable for riding (i.e. not for driving horses, or any other use of horses);
- is suitable for riding Icelandic horses
- fits the horse and is used correctly;
- is not included in the list of prohibited bits as published on the FEIF website.

All bits are allowed in all tests. Nothing may be added on to bits other than smooth bit guards and chain guards, and nothing else is allowed in the horse's mouth.

Horses may be ridden in bit-less bridles, provided they fit the general requirements described above.

The Chief Judge's decision about the use of any bit or bridle at a specific event is final for that specific event.

G8.2.3. Prohibited bits and bridles

Prohibited bits and/or bridles are bits and/or bridles that are clearly designed for another purpose (such as bits for driving horses) or are part of tack designed for a different riding style/culture, or are used in way other than designed for. Only reins that go directly from the rider's hands to the correct attachment point on the bit or bit-less bridle are allowed.

In addition to this general rule FEIF maintains a list of bits and bridles that are not allowed for specific reasons. The list includes a description and a picture of the specific bits or bridles or combinations of bits and bridles. The list is published on the FEIF website.



Sport: To have a specific bit and/or bridle added to the list of prohibited bits and bridles, national Sport Leaders, members of the FEIF Sport Committee and FEIF Licensed International Sport Judges can make a proposal to the FEIF Sport Committee. A clear description, a clear picture and proper reasoning should accompany such a request. The Sport Committee will review all. The annual sport leader meeting can decide to remove bits and bridles from the list of prohibited bits and bridles.

Breeding: The annual breeding leader meeting can decide on any changes on the list of prohibited equipment.

G8.3. Shoeing

G8.3.1. Shoeing of Breeding Horses

All horses shown ridden must be shod with a full set (4) of shoes. The shoeing shall be as well done as possible and the angle of the hoof must be in line with the pastern.

- The hoof length must be natural and not exceed 8.5 cm. Exceptions to the 8.5 cm rule can be made when stick measurements at the withers are 137-144 cm. These horses are allowed a hoof length of 9.0 cm. Horses that have a stick measurement of 145 cm or more are allowed a hoof length of 9.5 cm. Maximum differences in hoof length between front feet and back feet is 1.5 cm.
- The material of all four shoes shall be identical and must not exceed the specific weight of iron. The maximum thickness of the shoes is 8.0 mm and the maximum width is 23.0 mm. All 4 shoes must be identical regarding material and with. A difference in the thickness between front and back shoes of up to 2.0 mms is allowed.
- The shoe must fit the hoof. The shoe must not extend past the lengthened natural slant of the toe wall, and at the back past the perpendicular dropped from the bulbs of the heel. The use of sole, ring or any kind of artificial material to protect or repair the hoof is not allowed.
- If studs are used, 2 ordinary studs or stud nails must be used per shoe at the heel. The studs must suit the size of shoe.
- Max. size of studs allowed is (length x width x height) 15mm x 15mm x 12mm.
- Reinforcement welds are not allowed.

G8.3.2. Shoeing of Sport Horses

G8.3.2.1. Length of hoof

The angle of the hoof must be in line with the pastern. The hoof length must be natural and not exceed 9.0 cm. Exceptions to the 9.0 cm rule can be made when a written proof (e.g. from a breeding show or a veterinarian) is shown that the horse has a stick measurement of 145.0 cm or more, in which case a length up to 9.5 cm is allowed. Any artificial lengthening is forbidden. Soles/pads/rings are permitted and not included in the measurement.

G8.3.2.2. Shoes (Standard Iron Shoes)

If horses are shod all four feet should be shod. The only shoes allowed are those that are made for the purpose of serving as a shoe on a horse. Any shoe should have an opening at the hind side. All four shoes have to be made of the same material. The material used must not exceed the specific weight of standard iron. The shoe may have a maximum thickness of 10.0 mm and width of 23.0 mm (wear and tear included), and must be of an even shape.



The Chief Judge's decision about the acceptance of any shoe at a specific event is final for that specific event.

Size of the shoe

The size of the shoe must follow the size and form of the hoof.

Position of the shoe

The shoe must not extend past the lengthened natural slant of the toe wall, and at the back past the perpendicular dropped from the bulbs of the heel.

Studs

Two ordinary studs per shoe, riveted, welded or screwed, one on each side of the heel of the shoe, are allowed. A stud must not exceed the measurements 15mm x 15mm x 12 mm (l x w x h) and may only have a maximum of 4 welding spots. For studs with a core, the core must not protrude more than 3 mm beyond the outer case.

Clips

Three clips of a maximum thickness of 2 mm are allowed per shoe. Clips that have been welded are not allowed.

Reinforcement welds

Reinforcement welds are forbidden.

Leather and plastic rings and soles

Leather and synthetic rings or soles of a thickness of max. 5.0 mm and following the shape of the shoe are allowed between hoof and shoe. When filling material and/or a sole is used, a shoe of max. 8.0 mm thickness is allowed, otherwise a shoe of max. 10.0 mm is allowed. Apart from the filling material only one ring or sole per foot is allowed. Reinforcements in order to support the specific function of the sole/ring are allowed.

Wedged soles are allowed, with a maximum thickness of 8.0 mm at the heels and a maximum thickness of 2.0 mm at the toe, provided the hoof is in a correct angle to the pastern and with a correct length of the toe.

A ring may have one single bridge not wider than 23.0 mm joining one side to the other. A ring is deemed to be a sole if there is any other form of connection from one side to the other.

This is also valid when the connection consists of a woven construction. Reinforcements to keep the ring in place on the shoe are allowed.

If the hoof has any filling material with or without a sole only shoes up to a maximum of 8.0 mm thick are allowed.

As soon as any material is inside the hoof (including the shoe) the rules for soles apply, even if no sole is used.

The Chief Judge's decision about the acceptance of any ring or sole at a specific event is final for that specific event.



Prohibited shoes, rings and soles

Prohibited shoes, rings or soles are shoes, rings or soles that are clearly designed for a purpose other than riding horses.

G8.3.2.3. Alternative Shoes (Other Than Standard Iron Shoes)

All alternative shoes are allowed without filling as long as the weight does not exceed the weight of standard iron shoes of the same size. If the shoeing is glued onto the hoof, an identical spare must be available for inspection at the equipment check.

Alternative shoes must be used as manufactured without any modification.

Alternative shoes must follow the same rules as normal shoes regarding fit and placement on the hoof.

G8.3.2.4. Loss of a Shoe

If a horse loses a shoe or the shoeing becomes damaged during a test the rider must stop the performance.

- If this occurs during a preliminary round the rider is eliminated from the class and no marks are given.
- If this occurs in the finals or in a pace track class any marks and/or times earned before the loss of the shoe are kept including those from completed sections or runs. The rider receives a "0" for the remaining sections but is not eliminated.
- A horse found to have lost a shoe in the equipment check is not disqualified.

G8.3.2.5. Re-shoeing

A horse may not be re-shod once it has started its first test without the express permission of the Chief Judge.

G8.4. Additional equipment

Sport:

- The use of elastic bands to divide the manes of a horse equally is allowed in sport.
- In winter time the use of 'snow grip' (rings/soles with extra grip on the ground, to be used on slippery surfaces) is allowed for safety reasons, in addition to nails and studs as described under studs (see chapter on shoes). The ring/sole itself should fit otherwise in the description of the description of leather and plastic rings and soles.

G8.4.1. The whip

The whip must not be longer than 120 cm including the tassel. In pace races whips are forbidden. The rider can use only one whip at the time. The rule concerning whips is valid for the whole competition area, and for the entire duration of the competition.

G8.5. Protective equipment

It is not allowed to put more weight to the limbs than required for protection.



G8.5.1. Breeding shows

The total permitted weight of protective boots is 120 grams (total weight per leg of overreach boots or tendon boots) and they shall be of a dark colour, black or brown. If boots are used during the judgement of the ridden abilities the same equipment should be used throughout the presentation. If a boot falls off it should be put back on before the rider resumes the presentation.

Equipment which is listed on the FEIF website under “Prohibited equipment/Breeding” is not allowed.

G8.5.2. Sport competitions

Protective equipment above the sole of the hoof, not exceeding 250 g per leg, is allowed. The protective equipment may not be changed between entering the oval track and finishing the test.

If any part of the protective equipment falls off during the preliminary round, the rider must decide either to finish the test without this part or to retire.

Equipment which breaks or falls off during the final round, or in the preliminary rounds of five gait classes with more than one horse in the track, may be replaced at the judges' discretion, during the interval when the marks are shown, or in the five gait classes, when the horses are waiting for the pace run.

These rules are valid for the whole competition area and for the entire duration of the competition.

G8.5.2.1. Inspections

Inspection of shoes and protective equipment lies within the responsibility of the judges. If there is no mandatory shoeing check the riders should be given the opportunity of a voluntary check before the start of the competition. During the competition, Ring Stewards can check tack as each horse leaves the track after completing a test. If there is no mandatory check, there shall be a system, which randomly identifies a number of horses in accordance with the starting list. In this case one of the first three placed horses of every test shall also be drawn out. Riders must be prepared to remove the shoes of their horses if drawn out for inspection.

Any judge in doubt as to whether there has been a breach of the shoeing or protective equipment Rules may order an inspection to be carried out. One or more judges appointed for this purpose will carry out the inspection. The rider and the judges may call on the assistance of the official farrier or veterinary surgeon. The judges decide whether the shoes or the protective equipment are complying with the Regulations. They can demand that the shoes be removed and replaced. The rider concerned has no right to claim compensation. If the official farrier removes the shoes, the cost is to be paid by the organiser; otherwise it is the responsibility of the rider concerned.

Horses with soles may be selected by judges for a check (removal of one or more soles).

Normally the same horse will not have to have its shoes removed more than once at the same competition. The shoe and sole can be replaced, but only under supervision of the head judge or his representative.

The rider concerned has no right to claim compensation. If the rider refuses to follow the judges' instruction, the horse will be disqualified from the entire competition.



G9. Tracks

All tests should take place on approved tracks, either oval track, pace track or dressage ring, according to the specific requirements of the tests. The tracks have to meet the requirements described in these rules. Next to the entrance of each track there should be an area where riders can prepare their horses and a collecting area for the combinations to start

G9.1. Breeding - Tracks and facilities

G9.1.1. Tracks for conformation judgements

Where possible, all measurements and judgements of conformation shall take place indoors (riding arena/hall). A marked track, 20-30m long and 2-3m wide, with a level surface and a fence around it, is required for the conformation judgements.

G9.1.2. Tracks for judgement of gaits/ridden abilities

The gaits shall be shown on a straight, level track, 250m long and 4-6m wide, well fenced, but open at both ends.

The surface of the track should be identical to the surface of competition tracks, such as good oval tracks; the surface needs to be level and well compressed. It is also necessary that the track's condition be maintained throughout the whole show. Care must be taken so that traffic outside the track does not bother those showing horses on the track.

The track should be marked out prior to the start of the show and all facilities checked by the show organisers and a representative of the judges' panel.

Judges need good working facilities and a clear view of the track, about 25-30m away from the track.

G9.2. Sport - Tracks

G9.2.1. Oval track tests and details on tracks

All tests taking place on the oval track must be carried out on oval tracks, which satisfy the standard dimensions shown in the drawings in S14 (Addendum 9). When groups of riders are riding to the speaker's instructions, the time a specific section is shown shall be according to the table set by the FEIF Sport Committee and published in S11 (Addendum 5).

The track should be even and firm, 250.00 m long with an outer circumference of 271.69 m and an inner circumference of 246.56 m, and a width of 4.00 m, following the drawings included. The radius of the inner side of the curves should be 13 m, the radius of the outer side of the curves 17 m. The length of the long sides (between the curves) should be 70.44 m; the short sides (between the curves) should be 12.00 m. The fencing should be low and not disturbing horses or judges. Refer to the drawings for other measures. A gradient towards the inner side of the track (long sides and shorts sides between the curves) up to 3.75% and towards the inner side of the track in the curves up to 7.5% is allowed.*

The start and end of the long sides have to be properly marked.

* Recommendation 2019 for new tracks: There should be a minimal gradient of 1.5% toward the inner side of the track to drain water.



G9.2.2. Pace track tests and details on tracks

The track must be straight; 250 m long, even, firm and must have a width of at least 2 m per horse. The gradient over 100 m must not be more than 0,2% and there should be an approx. 8 m Starting section and an approx. 50 m slowing down section. The fencing must extend 10 m beyond the finishing line. Both sides of the track must be fenced in exactly along the edge of the track. Furthermore, one of the sides should be fenced in by a second fence approximately 5-10 m behind the first, behind which the spectators will be standing during the race. Every 50 m there must be a clearly visible, but not distracting meter marker. The Chief Judge must approve the track.

The pace test track should be straight, 210 m long, even, firm and have a width of at least 4 m. The pace track can be used for the pace test, with the appropriate markings as shown in drawings in S14.7 (Addendum 9).

G9.2.3. World Championship Tracks

The oval track must be 250.00 m long with an outer circumference of 284.21 m and an inner circumference of 246.52 m, and a width of 6.00 m, following the drawings included. A gradient towards the inner side of the track (long sides and shorts sides between the curves) up to 3.75% and towards the inner side of the track in the curves up to 7.5% is allowed. The fencing should be low and not disturbing horses or judges.

The pace track must be straight, 250 m long, even, firm and must have a width of at least 2 m per horse. The gradient over 100 m must not be more than 0,2% and there should be an approx. 8 m starting section and an approx. 50 m slowing down section. The fencing must extend 10 m beyond the finishing line. Both sides of the track must be fenced in exactly along the edge of the track. Furthermore, one of the sides should be fenced in by a second fence approximately 5-10 m behind the first, behind which the spectators will be standing during the race. Every 50 m there must be a clearly visible, but not distracting meter marker.

Next to the entrance of each track there shall be an area where riders can prepare their horses and a closed collecting area for the combinations to start.

The Director of Sport must approve the tracks and collecting area at or before the designated test event. The Chief Judge must approve the tracks and collecting area immediately before the start of the World Championships.



G10. Objections and Arbitration Rules

G10.1. General Principles

1. The decisions taken by the FEIF arbitration committee and the FEIF arbitration council concerning appeals and rulings are final.
2. In so far as jurisdiction rests with national Arbitration Committees, their decisions are final.
3. No one may be involved in any arbitral decisions, who is either directly concerned or has interests therein or is in any other way prejudiced.

The FEIF Arbitration Council is elected in accordance with Chapter 5 in the Statutes and has jurisdiction as set out therein.

Matters of doping of horses that are not dealt with by any national association or lawfully appointed competent authority can be brought to the FEIF Arbitration Council by the Board of FEIF. The Arbitration Council shall have the authority to decide in matters of doping of horses in accordance with the rules herein.

The Board of FEIF can bring matters that relate to any breach of FEIF Rules and Regulations or the FEIF statutes by an FEIF official.

All other disciplinary and arbitration matters are for the national level and handled by the national associations and under national laws and Regulations.

G10.2. Arbitration committees

If there is a dispute at an event an Arbitration committee must be formed consisting of the following:

G10.2.1. Breeding shows

- 1) The show manager or one delegate previously appointed by him.
- 2) A member of the organising committee.
- 3) The National Breeding Leader or a person appointed to act on his/her behalf
- 4) The chief judge or one member of the committee of judges previously appointed by him.
- 5) A spokesman for the breeders who are presenting horses for the breeding assessment, elected before the start of the Breeding show. If he/she has to be substituted the breeders have to be represented by a deputy member.

G10.2.2. Sport events

- 1) The competition manager or one by delegate previously appointed by him
- 2) A member of the organisation committee
- 3) The head judge or one member of the judge staff previously appointed by him
- 4) The sport representative of the organising national association or one representative previously appointed by him. At non-WorldRanking events this person does not need to be appointed.
- 5) A riders' spokesman, elected before the start of the competition by those actively competing. If the riders' spokesman has to be substituted, then the rider with the second highest votes will become the spokesman's representative.



G10.2.3. World Championships

- 1) The competition manager or a representative previously appointed by him
- 2) A member of the organisation committee
- 3) The head judge or one member of the judge staff previously appointed by him
- 4) The sport or breeding representative of FEIF or a previously appointed member of the FEIF-sport or breeding committee
- 5) A rider's spokesman, elected before the start of the tournament by the Team-spokesmen (one per team). If the rider's spokesman has to be substituted, the rider with the second highest votes will become the spokesman's representative. The appointed representatives and members may only take part in the meetings of the arbitration committee according to the general principles or if the substituted representative is prevented from attending the meeting.

Breeding arbitration committee: The Arbitration committee can never have more than 2 representatives of the same nationality in the committee.

G10.3. Rules of procedure for Arbitration Committees or disciplinary bodies of first instance

The following Rules specify the procedure for Arbitration Committees at the World Championships, and shall also serve as a minimum requirement for National Arbitration or disciplinary bodies of first instance in the member associations.

For the purpose of these Rules reference to arbitration committees shall also mean national disciplinary bodies of first instance.

Interested parties may submit a written complaint to the Arbitration Committee when they deem that their rights and interests have been violated. The complaint must be lodged in writing and within 24 hours^{*} of the complainant having learned, or having been able to learn, of the act or incident which he considers a violation of his rights or interests. The complaint shall provide information on the complainant, the party against which the complaint is directed, the manner of the alleged violation and the evidence supporting the complaint. The complaint may be accompanied by any documents that the complainant deems to support it. The complaint and its attachments shall be sent to the Arbitration Committee in duplicate.

The party against which the complaint is directed, or his representative, shall be informed without delay of the complaint. The Arbitration Committee shall decide on the place and time of the hearing and shall notify the parties of this on a suitable notice. The Arbitration Committee shall grant the party against which the complaint is directed, or his representative, an opportunity to express himself on the substance of the complaint and gather evidence and information. The defending party is free to either submit his observations orally or in writing. The Arbitration Committee may gather evidence and information on its own initiative and may require a report from a party if this is considered necessary for the clarification of the case. The Arbitration Committee may summon a witness of its own motion or on application by a party. An application by a party for the examination of a witness shall state precisely about what facts and for what reasons the witness should be examined.

If the complainant, or his representative, fails to make an appearance at the time his complaint is brought up in the Arbitration Committee, the committee may regard his complaint as cancelled.

^{*} For objections not occurring during an active Sport or Breeding event. Objections occurring during an active event must be lodged within a 30-minute time window from the time of occurrence. (G10.3.1)



Proceedings before the Arbitration Committee are conducted orally. Minutes are to be taken, which should at least include the following information: Members of the Arbitration Committee, place and time of the proceedings, Parties present, Issues and decisions of the committee. Arbitration Committee hearings are public. The chief judge or president shall conduct the proceedings of the Arbitration Committee. The complainant, or his representative, shall be given a brief time to express himself on the comments from the respondent and the respondent, or his representative, shall in turn be given a brief time to express himself on the comments of the complainant.

The deliberations of the committee shall be conducted in private. Every member taking part in the deliberations shall state his opinion and the reasons for it. Decisions by the Arbitration Committee are taken on a simple majority. In the event of votes being equal, the chief judge or president will have the casting vote. The Arbitration Committee shall make a final award within 24 hours from the submission of the complaint. The decision shall be reasoned and delivered immediately in writing to the party concerned. The decision is to be delivered to the Director of the FEIF department involved and he shall inform the national representatives of the reprimands and suspensions issued. The party concerned may lodge an appeal against a decision of the Arbitration Committee imposing a suspension penalty to the Arbitration Council within a period of 2 weeks.

G10.3.1. Objections at an Event

Anyone being put at a disadvantage due to a violation of the conditions of the schedule or the Rules has the right to object; furthermore, the same applies to all judges, the organiser and the competition manager. At World Championships team leaders have their own particular right of objections.

Objections to judges' decisions can only be based on the violation of Rules or the abuse of the power of discretion.

Objections must be made in writing to the competition manager up to half an hour after the occurrence, accompanied by a deposit of € 200,- or the equivalent in foreign currency, € 50 as a non-refundable fee..

Objections to schedules and showing procedures are to be lodged before the start of an event, or the relevant class. The deposit will be refunded, if it is decided that there are reasonable grounds for the objection.

G10.4. Appeals to the Arbitration Council

Appeals may be lodged with the Arbitration Council against decisions taken by the Arbitration Committee within 3 days of the date on which the parties involved are informed of the decision, if suspension penalties are imposed. The appellant shall deposit a sum deemed sufficient by the Arbitration Council to cover the costs of the appeal. The sum is refundable if the Arbitration Council finds in favour of the appellant.

G10.5. Appeals at national level

Appeals on decisions taken by an Arbitration Committee shall be lodged within the timeframe set out in the national Rules. Procedures on the appeal shall also be set out on the national Rules.



G10.6. Guidelines for conflicts of interest - Breeding

These procedures are indicative and cannot be a prerequisite for annulment or alteration of an assessment that has been determined by a judges' panel. The owner has always the option to get re-assessment of the horse at another show. Process regarding complaints and disciplinary violation as well as penalties for those is explained in the rules.

G10.6.1. Rules for employees of a breeding show

Whenever any of the following circumstances occur, the judge is recommended to leave the committee during the assessment of that horse. The remaining committee is allowed to perform the assessment.

- Employees shall follow the principle that their work raises trust and respect. They apply professionalism, ensure that all participants are treated equally and strengthen the collaboration and cooperation between employees, owners and riders.
- If the show is held at a private stud farm/place the owner of the facility is not to be a member of the show's staff (ring master, secretary or speaker), if he/she is owner of horses being presented at the show. (Exceptions from this rule can be applied for by the breeding judge committee of FEIF in special circumstances).
- Employees shall strive to increase their professional knowledge.
- Employees are required to comply with rules and regulations governing the breeding shows.
- Judge is not to participate in assessment work at national level if his/her principal occupation is extensive horse breeding, sale of horses or stallion fees. If in doubt regarding such general eligibility of a judge, the Breeding Judges' committee and the breeding leader of FEIF decides on this before the structure of jury panels are determined each year.

G10.6.2. Guidelines for judges

G10.6.2.1. Judge stands outside of judging panel if:

- The judge is a shareholder in, the former or current owner of that horse or its parent/parents.
- The judge is the breeder of the horse or its parent/parents.
- The judge has trained the horse.
- The judge is or has been a partner of the rider, owner or breeder of the horse. The judge or his partner is a close relative (wife/husband or living together in the equivalent relationship, child, grandchild, parent, grandparent, sister/brother or their children) of the breeder, rider or owner of the horse.
- Judge has payed respective riders pay for taming, training or showing of horse/horses the past year.
- The judge has accepted gifts, benefits or other perks from the owner or breeder of the horse that may be considered to affect his credibility.
- The judge is a subordinate of the rider, owner or breeder of the horse.
- Whenever the judge feels there is a conflict of interest that could influence his ability to perform the assessment.

G10.6.2.2. Panel work:

- Unprejudiced practices are always expected.



- Good appearance, courtesy, modesty and neutrality is honoured.
- Judges are expected to give their work full concentration, be fit for the job and be sober while judging.

G10.6.2.3. Responsibilities of the head judge:

- The head judge is responsible for the execution of assessment of the relevant breeding show.
- The head judge is, along with show manager responsible for tracks, other facilities, measurements and health inspections meet quality and regulatory requirements.
- The head judge shall ensure that FEIF breeding rules and regulations are observed.
- The head judge shall ensure that assessment work is progressing efficiently and results are obtained.
- The head judge shall notify the national breeding leader if something in the judgments or running of the breeding show that is in violation of the guidelines for conflict of interest.
- The head judge shall return a head judge report in WorldFengur.

G10.6.2.4. Process of disciplinary violations/complaints

1. The Breeding judge committee of FEIF and Breeding leader of FEIF.
2. The Breeding judge committee of FEIF can caution a judge or dismiss from panel work on short or long term basis, if rules are not followed.

G10.6.3. Disciplinary measures and objections at breeding shows

G10.6.3.1. Disciplinary measures against the rider or owner

1. Riders, supervisors and/or owners of the horse should show courtesy and polite conduct,
2. Breaches of the Breeding Rules, or the code of conduct, and unfair behaviour of a rider or owner may be subject to disciplinary measures.

G10.6.3.2. Breaching Rules

Any person is guilty of a breach of the rules, who

- brings the name of the association and/or Icelandic horse into disrepute,
- treats a horse unfairly, makes excessive demands on it or hits it,
- violates established principles of the prevention of cruelty to animals act,
- presents the horse, although the horse is suffering from an obvious infectious or contagious disease,
- makes use of any substance, which is suitable for artificially influencing the performance of a horse during its presentation, or any person attempting this use, on entering, or participating in such an event is guilty of deception or attempted deception,
- as an organiser does not fulfil those obligations imposed by the rules,
- does not need an arbitrational ruling.

G10.6.3.3. Types of Disciplinary Measures

1. Warning
2. Public reprimand (FEIF register of warnings)



3. Disqualification from further participation in the show – should follow when the seriousness of the offence exceeds a warning or a public reprimand, or the offence has occurred on more than one occasion, or was of a serious or fundamental nature.

G10.6.3.4. G10.6.2.5 Procedures

- A warning can be given by any judge or the show manager.
- A public reprimand can only be given by judges' panel.
- The decision of implementing disciplinary measures shall be announced to the rider, or a representative, immediately after the decision has been taken. Whenever the judges need time to clear up a case, the rider, or a representative, must be informed at once that the judges are considering disciplinary measures.

G10.7. Disqualifications and Disciplinary measures Sport

G10.7.1. Scope

Rules concerning disqualification and disciplinary measures are valid for any event from the first moment the riders and/or his horse(s) enter the area of the event until the moment the rider and his horse(s) have left the event venue for the last time.

Riders are considered responsible for the horse(s) with which they are participating in any way.

G10.7.2. Register

FEIF maintains a register containing all reports of warnings and suspensions reported to FEIF as a consequence of disciplinary measures described in this chapter and those reported in accordance with the respective chapter of the Statutes.

Warnings and suspensions shall be notified to FEIF within 2 weeks after the case was concluded. The notification shall be posted verifiably in registered post before the time limit expires or sent by email. If the notification is sent by email, FEIF must confirm the receipt of the email. A copy of the notification shall be sent to the parties of the case. FEIF does not take a stand with respect to the case in question apart from ensuring that the decision was taken by a competent arbitration body of the member association in question.

G10.7.3. Measures

The following measures may be used alone or combined if the Rules are breached:

- Elimination from a class
- Warning not to be published
- Warning to be published
- Disqualification from a event
- Suspension

Disqualification from an event and suspension should always be imposed combined with a warning to be published.



G10.7.4. Disqualifications and Disciplinary measures

Breaches of the Regulations are classified and treated according to the table below. Conditions are indicated by figures as follows:

- ❶ If observed and marked by judges judging at the track:
 - At least 2 red cards shown: elimination from the class.
 - At least 2 yellow cards shown: warning, eventually to be published. A judge can show a red and a yellow card simultaneously.
- ❷ may be appealed to the arbitration committee
- ❸ may be appealed to the arbitration council
- ❹ observed by a judge or an official outside the track
- ❺ decided by the judges' meeting at the end of the event
- Ⓜ after veterinary inspection only



OFFENCE	Elimination from a test	Warning - Not to be published	Warning – To be published	Disqualification from an event	Suspension
A) Rider disobeys Rules on entering the track, saluting or leaving the track.	1				
B) Rider leaves the saddle without permission.	1				
C) Rider neglects Rules for the test in which she/ he competes	1				
D) Breach of the Rules on tack	1				
E) Bringing the name of the association and/or Icelandic horse sport into disrepute		2	2	2	3
F) Unfair or brutal treatment of the horse on or outside the track	1 or 4	1 or 4 + 5	1 or 4 + 5	1 or 4	1 or 4 + 3
G) Offence against codes of conduct	1 or 4	1 or 4 + 5	1 or 4 + 5	1 or 4	1 or 4 + 3
H) Competing with a horse suffering from an infectious or contagious disease	1 or 4 + V	1 or 4 + 5 + V	1 or 4 + 5 + V	1 or 4 + V	1 or 4 + 5 + V
I) Using substance, which might artificially influence performance of horse or rider	1 or 4 + V	1 or 4 + 5 + V	1 or 4 + 5 + V	1 or 4 + V	1 or 4 + 3 + V
J) Deception, or attempted deception, entering or participating in an event	1 or 4	1 or 4 + 5	1 or 4 + 5	1 or 4	1 or 4 + 3
K) Not heeding an arbitral ruling	4			4	



G11. Appendix 1: Codes of Conduct

G11.1. Code of Conduct for Sport Judges at WorldRanking events

By accepting an invitation to judge at FEIF WorldRanking event the judge commits to act in accordance with the following standards:

1. The judge seek to have a neutral, independent and fair position towards riders, owners, trainers, organizers and other officials and integrate well into a team. Financial and/or personal interest shall not influence or be perceived to influence their way of judging.
2. The judge will avoid any actual or perceived conflict of interest. Activities which will lead to or may lead to a “conflict of interest” when judging at a FEIF WorldRanking event includes but are not limited to:
 - Coaching/training a horse/rider during and two days prior to an event.
 - Judging a test where one is owner/part-owner of horses taking part.
 - Being in a situation of financial dependence or gaining financial profit from owners, riders, trainers, organizers or other related organizations.
 - Having a close personal relationship with a competitor. A judge should not judge classes where his/her spouse, children, siblings or parents are competing.
 - Inappropriate use of social or other media before, during and after the event.
3. The judge will notify the chief judge and the event organizer of possible conflicts of interest or situations that may be perceived as such.
4. During the event the judge will be punctual and conduct him/herself in a professional manner at all times. The judge will be well prepared for the tests he/she is judging and must cooperate well with the organizer, colleagues and other officials. The judge will not consume alcohol until after the day's judging is finished and will keep the use of mobile phones and/or other electronic communication devices to the minimum.

By accepting an invitation to judge a FEIF WorldRanking event the judge commits to these standards and is aware that FEIF have the right to undertake disciplinary actions against judges who do not follow this Code of Conduct and FEIF rules. Such disciplinary actions may consist of: (1) Warning letter (2) Temporary suspension and (3) Removal from the FEIF International Judges' list.



G11.2. Code of Conduct for World Championship Judges

As a judge at the World Championships for Icelandic Horses I commit to act in accordance with the following standards:

1. I will strive to have a neutral, independent and fair position towards riders, owners, trainers, organizers and other officials and integrate well into a team. Financial and/or personal interest will not influence or be perceived to influence my way of judging.
2. I will avoid any actual or perceived conflict of interest. Activities which will lead to or may lead to a “conflict of interest” when officiating at a World Championships, include but are not limited to:
 - Training a horse/rider for more than three days in the eight months before the World Championships.
 - Acting as Team Leader of national teams at international level or being responsible/co- responsible for selecting teams and/or individuals or training riders on World Championships teams.
 - To be owner/part-owner of horses taking part in the event.
 - Being in a situation of financial dependence or gaining financial profit from owners, riders, trainers, organizers or other related organizations.
 - Having a close personal relationship with a competitor.
 - Nationalistic judging.
 - Inappropriate use of social and other media before, during and after the event.
3. I will notify the responsible FEIF Director of possible conflicts of interest or situations that may be perceived as such.
4. During the World Championships I will be punctual and correct in the way of behavior.
5. I will be well prepared for the tests I am judging and will cooperate well with the organizer and my colleagues.
6. I will be dressed appropriately and always be aware I represent FEIF.
7. I will not use electronic communication, including mobile phones, while judging.
8. I will not consume alcohol until after the day's judging is finished.

By signing this codex I commit to these standards and I am aware that FEIF has the right to undertake disciplinary actions against judges who do not follow the Codex and FEIF rules. Such disciplinary actions may consist of: (1) Warning letter (2) Temporary suspension and (3) Removal from the FEIF International Judges' list.





FEIF Sport Rules

Appendices

Valid as of April 1, 2019

Rules for Icelandic Horse Sport Events

Contents SPORT

S1	Rules for Sport Competitions.....	141
S1.1	Invitations and entries	141
S1.2	Judges	141
S1.3	Starting order	141
S1.4	Demonstration rider.....	141
S1.5	Combination.....	142
S1.5.1	Four Gait.....	142
S1.5.2	Five Gait	142
S1.6	Disqualification & Elimination	142
S1.7	Withdrawals	143
S2	Oval track.....	144
S2.1	Judges	144
S2.2	Marks	144
S2.2.1	Preliminary rounds	144
S2.2.2	Finals	144
S2.3	Test procedure.....	144
S2.3.1	Preliminary rounds with one rider on the track.....	144
S2.3.2	Finals and preliminary rounds with more than one horse on the track	145
S2.4	Left rein and right rein groups.....	145
S2.5	Finals	145
S2.6	Tie breaks	145
S2.7	Music	145
S2.8	Test Descriptions	146
S2.8.1	T1 – Tölt Test.....	146
S2.8.2	T2 – Tölt Test.....	147
S2.8.3	T3 - Tölt	148
S2.8.4	T4 – Tölt Test.....	149
S2.8.5	T5 – Tölt.....	150
S2.8.6	T6 – Tölt.....	151
S2.8.7	T7 – Tölt.....	152
S2.8.8	T8 – Tölt.....	153
S2.8.9	V1 – Four-gait test.....	154
S2.8.10	V2 - Four gait	155
S2.8.11	V3 – Four Gait.....	156
S2.8.12	V4 – Four Gait.....	157



S2.8.13	V5 – Four Gait.....	158
S2.8.14	V6 – Four Gait.....	159
S2.8.15	F1 – Five-gait Test	160
S2.8.16	F2 - Five gait	161
S2.8.17	F3 - Five gait	162
S3	Pace track.....	163
S3.1	Restrictions	163
S3.2	Judges	163
S3.3	Time keeping	163
S3.4	Scoring in races	164
S3.5	Records	164
S3.6	Test Descriptions	165
S3.6.1	P1 – Pace Race 250 m	165
S3.6.2	P2 – SpeedPass: Pace race 100 m with flying start	168
S3.6.3	P3 - Pace race 150 m	169
S3.6.4	PP1 – Pace Test	170
S3.6.5	PP2 – Pace Test	172
S4	Dressage tests.....	174
S4.1	Dressage arena.....	174
S4.2	Judges	174
S4.3	Test Descriptions	174
S4.3.1	FS1 - Free Style Performance.....	174
S4.3.2	FS2 - Riding in the dressage arena.....	176
S4.3.3	FS3 - In-hand showing in the dressage arena	177
S5	Figures Tests.....	178
S5.1	Dressage arena.....	178
S5.2	Judges	178
S5.3	Music	178
S5.4	Eligible horses.....	178
S5.5	Boots & Protective Equipment.....	178
S5.6	Test Descriptions	179
S5.6.1	FG1 – Level 1	179
S5.6.2	FG2 – Level 2	180
S5.6.3	FG3 – Level 3	181
S6	Other tests	182
S6.1	FR1 – Flag race	182
S6.1.1	Track.....	182



S6.1.2	Starting order	182
S6.1.3	Start	182
S6.1.4	Judging	182
S6.1.5	No Mark	182
S6.2	TR1 – Trail	183
S6.2.1	Track.....	183
S6.2.2	Start	183
S6.2.3	Judging	183
S6.2.4	Requirements.....	183
S6.3	CR1 – Countryside riding	184
S6.3.1	Start	184
S6.3.2	Judging	184
S6.3.3	Requirements.....	184
S6.3.4	General remarks	184
S7	World Championships	185
S7.1	Teams.....	185
S7.2	Horses	185
S7.2.1	Eligible horses.....	185
S7.2.2	Shoeing.....	185
S7.2.3	Inspections.....	185
S7.3	Riders	186
S7.3.1	Eligible riders	186
S7.3.2	Riders' dress/equipment.....	186
S7.4	Judges	186
S7.4.1	Chief Judge.....	186
S7.4.2	Appointment of judges.....	186
S7.4.3	Judges and conflicts of interest	187
S7.4.4	Ring Stewards.....	187
S7.4.5	Judges' Seminar and Conference	187
S7.4.6	Judges' meeting.....	187
S7.4.7	Judges' Meetings during World Championships	187
S7.4.8	Judges' dress/equipment	187
S7.5	Time Keeping.....	187
S7.6	Starting order	187
S7.7	Punctuality	188
S7.8	Demonstration rider.....	188
S7.9	Team competition.....	188



S7.10	Arbitration Committee.....	188
S7.11	Tests	188
S8	Appendix 1: WorldRanking.....	189
S9	Appendix 2: International Sport Judge Examination.....	191
S9.1.1	Purpose	191
S9.1.2	Candidate Requirements.....	191
S9.1.3	Board of Examiners.....	192
S9.1.4	Content of the Examination	192
S9.1.5	Execution of the Practical Portion.....	193
S9.1.6	Calculation of the Results of the Practical Portion	194
S9.1.7	Re-Examination.....	194
S9.1.8	Objections	194
S10	Appendix 3: Time table P1 Pace Race 250 m	195
S11	Appendix 4: Time table P2 SpeedPass 100 m.....	201
S12	Appendix 5: Time table P3 Pace Race 150 m	204
S13	Appendix 6: Times for group tests and finals	209
S14	Appendix 7: Ground work at events	210
S15	Appendix 8: Description of Start boxes.....	211
S16	Appendix 10: Drawings.....	212
S16.1	Oval track 250 m / 4 m	213
S16.2	Oval track 250 m / 6 m	214
S16.3	Oval track 250m / 300m Combination	215
S16.4	Entering the oval track and beginning of the test.....	216
S16.5	Dressage arena.....	217
S16.6	Pace track environment.....	218
S16.7	Pace test track configuration	219
S16.8	P1 track configuration	220
S16.9	P2 track configuration	221
S16.10	Trail.....	222
S16.11	Figures Court	226



S1 Rules for Sport Competitions

This section of the FEIF Rules and Regulations contains the specific rules applicable to Sport competition at international, national, and other Icelandic horse events. These events are also subject to the Veterinary Rules and Code of Conduct of the Fédération Equestre Internationale (FEI).

S1.1 Invitations and entries

The organiser of a competition will draw up and publish a schedule and entry form to enter teams, horses and riders for a competition. These will clearly set out all the fees involved, and what rules are applicable.

S1.2 Judges

All FEIF Sport tests should be judged by at least three nationally approved judges. For oval track tests at World Ranking competitions 5 judges should be used. This is also recommended for all other competitions.

At each competition a chief judge should be appointed. His responsibilities are:

- to draw lots for who shall be checked when a shoeing, sole or doping inspection is required;
- to uphold the interests of the Judges at the competition;
- to head the judges' briefing before and after the competition;
- supervise the shoeing control and the control of tack;
- to submit a written report on the competition.

When the organiser did decide to carry out doping tests, the chief judge will draw lots for the horses to be sampled.

S1.3 Starting order

The starting order will be drawn by lot. Any horse entered for a test after the starting order has been set has to start at the beginning of the test.

The starting order must be strictly adhered to, any change even with the consent of those concerned is forbidden.

S1.4 Demonstration rider

A demonstration rider should ride the test 15 minutes before the start of each class. This performance is to be discussed by the judges in order to ensure uniform scoring.



S1.5 Combination

Marks given in the preliminary rounds will be the marks taken into account.

S1.5.1 Four Gait

The winner of the Four Gait Combination is the rider who gets the highest sum of marks in two tests. From each group only one discipline counts.

Group I:	Tölt	T1	<i>or</i>
	Tölt	T2	
Group II:	Four Gait	V1	

S1.5.2 Five Gait

The winner of the Five Gait Combination is the rider who gets the highest sum of marks in three tests. From each group only one discipline counts.

Group I:	Tölt	T1	<i>or</i>
	Tölt	T2	
Group II:	Five Gait	F1	
Group III:	Pace race 250 m	P1	<i>or</i>
	Pace test	PP1	<i>or</i>
	SpeedPass	P2	

If applicable and properly announced, Pace Race 150 m (P3) may be used instead of P1.

S1.6 Disqualification & Elimination

A combination shall be eliminated if:

- the rider falls from his horse or dismounts without permission;
- the horse leaves the oval-track between entering the track and the beginning of the test;
- the horse leaves the oval-track between the end of the test and the final exit from the track;
- the horse leaves the oval track between the beginning and the end of a test;
- the horse crosses its own line on the pace track after the horse has been called in by the speaker;
- *the horse is ridden in a circle or clearly asked to back in a preliminary round on the oval track unless required by the test or requested the speaker;*¹
- the horse shows serious disobedience;²
- the horse is unable to be checked when selected for an equipment check as determined by the Chief Judge and after being given ample opportunity to calm down before the check.

¹ This rule is valid after entering the track and the end of the test - See also S2.3. – Test procedure

² This rule is valid from the moment the horse is starting to enter the track to the moment the horse has left the track.



If any of the above-mentioned things happen in the finals during one part of a test or in the intervals when the marks are shown, the horse will be ranked in the relevant final according to the marks received so far.

- A horse has left the track, when it has placed all four feet outside the oval track.
- An elimination is valid if it is shown by at least two judges.
- Judges may decide not to eliminate the combination if it is clearly seen that an exceptional external disturbance caused the horse to leave the track.
- If a combination is eliminated in one of the finals because of breaking the rules regarding tack, equipment and shoeing, the horse is eliminated from the whole class and will not be ranked in that test.
- A combination eliminated due to a breach of rules (horsemanship, equipment) in one heat in a race or Pace Test is eliminated from the complete race or test, even if not all heats have taken place yet.
- A rider who skips the equipment check shall be disqualified from all tests at the current tournament including the forfeiture of any prizes already given.

S1.7 Withdrawals

Riders and horses are expected to be fit for the preliminary rounds and pace tests unless stated differently latest one hour before the start of the test concerned. Withdrawal after this time limit will only be accepted if the horse or rider is declared unfit by a veterinary surgeon who has examined the horse on site or a doctor respectively or the Chief Judge; otherwise the rider is disqualified from the event including forfeiture of marks and prizes already given.

In competitions with teams all team leaders must declare the riders and horses involved fit to take part in the final rounds at the latest one hour before the first final for the relevant test begins. In competitions without teams, riders and horses are expected to be fit for the finals unless stated differently one hour before the first final for that relevant test begins.

Withdrawal after this time limit will only be accepted if the horse or rider is declared unfit by a veterinary surgeon who has examined the horse on site or a doctor respectively or by the Chief Judge; otherwise the rider is disqualified from the event including forfeiture of marks and prizes already given. The Chief Judge shall make an immediate report to the FEIF Registrar of Bans and Warnings issuing the rider a two-week ban starting from the Monday following the last day of the event.

If for any reason a horse is withdrawn or disqualified from a final and the total number of horses in the finals drops below 10 (or 5, if there is no B-final), the next available highest placed horse in the preliminary round will move up. If two or more horses share the position involved, all horses involved qualify for the final round in question.

If a rider has two or more horses in either the A- or B-final, he has to decide with which horse he will start in each final at least one hour before the start of each final. The other horse(s) of this rider will be ranked in the order they had in preliminary round in the last position(s) of that final. Subsequent riders can take the free position(s). If two or more of the subsequent riders share the same position, all horses involved qualify for this final.



S2 Oval track

S2.1 Judges

5 or 3 judges judge oval track tests individually and separately. The judges score openly.

S2.2 Marks

S2.2.1 Preliminary rounds

The judges use a scale of marks per section from 0.0 to 10.0 (inclusive), with half points. Their final mark is rounded to one decimal place. In tests with only two sections judges are allowed to add or detract 0.1 from this final mark. In addition, judges are allowed to deduct up to 2.0 (with half points) from the final mark for bad riding and/or rough aids³.

Only the final mark is shown. If technically possible, the single marks per section may be shown. With 5 judges the highest and lowest mark will be disregarded. The final score calculated by the secretariat is the arithmetic mean of the three final marks, rounded to two decimal places. Rounding is done following the common mathematical rules.

S2.2.2 Finals

The judges use a scale of marks per section from 0.0 to 10.0 (inclusive), with half points. Judges show their marks after each section. With 5 judges the highest and lowest mark will be disregarded. The mark per section calculated by the secretariat is the arithmetic mean of the three marks, rounded to two decimal places. The final score calculated by the secretariat is the arithmetic mean of the respective marks per section including the weighting factor per section, rounded to two decimal places. Rounding is done following the common mathematical rules.

S2.3 Test procedure

S2.3.1 Preliminary rounds with one rider on the track

- The horse must enter the oval track and proceed directly to either one of the short sides. However, the horse must not pass beyond the end of the short side without beginning the test. Possibilities of entering and beginning the test with the entrance on the long or on the short side are shown on the drawing in S2.4.
- The rider must salute the judges visibly by nodding his head, thus indicating the beginning of the test.
- The change between the sections should be at the middle of the short side. An exception is in pace, which is shown only on the long sides.
- To have marks for any gait, the gait should be shown for the equivalent of the length of a long side. Walk must be shown for the equivalent of half of a long side.
- Having finished the last section of the test, the rider must have brought his horse back to walk by the middle of the long side at the latest.
- Exit via the oval track. The rider may circle the horse at the gate after the test is completed.

³ Judges will use the yellow card if a deduction for rough riding has been made.



S2.3.2 Finals and preliminary rounds with more than one horse on the track

The horses must enter the oval track at the speaker's command on the rein on which the first section is begun (see S2.4). The riders spread themselves evenly around the oval track. The beginning and the end of each section is directed by the speaker.

During the intervals when the marks are being shown, the horses may only be ridden at walk. In order to spread out, the riders can circle at the request of the speaker, under supervision of the chief judge.

Exit via the oval track.

S2.4 Left rein and right rein groups

In preliminary rounds with more than one horse on the track the riders may choose their starting rein when they enter the competition. Starting groups will be created based on the riders' choice of rein. When no preference is indicated, left rein is assumed to be the preference. Riders will start the preliminary on the rein specified in the starting order.

In finals, the majority of the riders determine the rein on which the first section is begun. In the event of a tie the vote of the preliminary round's winner is doubled. If this does not break the tie, the decision is made by coin toss.

S2.5 Finals

The best five horses from the preliminary round qualify for the final round called the A-final. If two or more horses share the fifth position, all horses involved qualify for the final round.

If there are sufficient participants, the organiser can arrange a final round (6th - 10th place) called B-final. The winner of the B-final can take part in the A-final. If the winner decides not to take part in the A-final, no other can take his place.

The organiser can also arrange a further final round (11th - 15th place) called C-final. The winner of the C-final can take part in the B-final. If the winner decides not to take part in the B-final, no other can take his place.

S2.6 Tie breaks

In the case of equal marks for the first place, the judges determine the placing using the marks they gave before and showing the ranking, where they can only use the first position once. If horses have equal marks in other than first place they will share the place.

S2.7 Music

When a rider is alone on the oval track, he can request to have the music turned off.

The chief judge decides the volume of the music.



S2.8 Test Descriptions

S2.8.1 T1 – Tölt Test

This test is performed on the oval track.

S2.8.1.1 Eligible horses

Combinations entering this class are excluded from other tölt tests at the same event.

S2.8.1.2 Preliminary Round

Riders compete individually.

Sections:

1. Begin at the middle of the short side and ride one round in slow tölt on either rein.
Return to walk at the middle of the short side and change rein.
2. From the middle of the short side ride one round in slow tölt, lengthen stride distinctly on the long sides.
3. From the middle of the short side ride one round in fast tölt.

S2.8.1.3 Final Round

The finalists show the required sections on both reins as instructed by the speaker as described in S2.3.2.

The speaker shall instruct the riders to walk their horses in a **relaxed** manner for a period of 60 seconds at the rein change during the second section (tempo differences) of the final. The speaker shall instruct the riders to walk their horses for 120 seconds at the rein change during the third section (fast tölt) of the final.



S2.8.2 T2 – Tölt Test

This test is performed on the oval track.

S2.8.2.1 Eligible horses

Combinations entering this class are excluded from other tölt tests at the same event.

S2.8.2.2 Preliminary Round

Riders compete individually. The rider has three rounds at his disposal to show the following gaits in the following order:

Sections:

1. any speed tölt.
2. slow, steady and calm speed tölt.
Return to walk and change rein.
3. slow to medium speed tölt, holding both reins in one hand clearly showing no rein contact with the horse's mouth.

Each section may be shown only once, for one round. The marks for section 3 will be doubled.

S2.8.2.3 Final Round

The finalists show the required sections including rein changes as instructed by the speaker as described in S2.3.2.



S2.8.3 T3 - Tölt

S2.8.3.1 Eligible horses

Combinations starting in this test are excluded from other tölt tests at the same event.

S2.8.3.2 Preliminary Round

The test is ridden in groups of up to three riders on the oval track. The horses show the three sections as instructed by the speaker as described in S2.3.2. They start on the rein as set in the starting list.

Sections:

1. slow tölt.
Return to walk and change rein.
2. slow tölt; lengthen stride distinctly on the long sides, on the short sides slow.
3. fast tölt.

S2.8.3.3 Final Round

The finalists show the required sections including rein changes as instructed by the speaker as described in S2.3.2.



S2.8.4 T4 – Tölt Test

S2.8.4.1 Eligible horses

Combinations entering this class are excluded from other tölt tests at the same event.

S2.8.4.2 Preliminary Round

The test is ridden in groups of up to three riders on the oval track, instructed by the speaker.

Sections:

1. any speed tölt.
2. slow, steady and calm speed tölt.
Return to walk and change rein.
3. slow to medium speed tölt, holding both reins in one hand clearly showing no rein contact with the horse's mouth).

The marks for section 3 will be doubled.

S2.8.4.3 Final Round

The finalists show the required sections including rein changes as instructed by the speaker as described in S2.3.2.



S2.8.5 T5 – Tölt

S2.8.5.1 Eligible horses

Combinations starting in this test are excluded from other tölt tests at the same event.

S2.8.5.2 Preliminary round

The test is ridden in groups of up to five riders on the oval track. The horses show the sections as instructed by the speaker as described in S2.3.2. They start on the rein as set in the starting list.

Sections:

1. slow tölt
Return to walk and change rein.
2. fast tölt on the long sides, slow tölt on the short sides.

S2.8.5.3 Final round

The finalists show the required sections including rein changes as instructed by the speaker as described in S2.3.2.



S2.8.6 T6 – Tölt

S2.8.6.1 Eligible horses

Combinations starting in this test are excluded from other tölt tests at the same event.

S2.8.6.2 Preliminary round

The test is ridden in groups of up to five riders on the oval track. The horses show the sections as instructed by the speaker as described in S2.3.2. They start on the rein as set in the starting list.

Sections:

1. Any speed tölt
Return to walk and change rein.
2. slow to medium speed tölt, on the long sides holding both reins in one hand clearly showing no rein contact with the horse's mouth.

S2.8.6.3 Final round

The finalists show the required sections including rein changes as instructed by the speaker as described in S2.3.2.



S2.8.7 T7 – Tölt

S2.8.7.1 Eligible horses

Combinations starting in this test are excluded from other tölt tests at the same event.

S2.8.7.2 Preliminary round

The test is ridden in groups of up to five riders on the oval track. The horses show the sections as instructed by the speaker as described in S2.3.2. They start on the rein as set in the starting list.

Sections:

1. slow tölt
Return to walk and change rein.
2. any speed tölt

S2.8.7.3 Final round

The finalists show the required sections including rein changes as instructed by the speaker as described in S2.3.2.



S2.8.8 T8 – Tölt

S2.8.8.1 Eligible horses

Combinations starting in this test are excluded from other tölt tests at the same event.

S2.8.8.2 Preliminary round

The test is ridden in groups of up to five riders on the oval track. The horses show the sections as instructed by the speaker as described in S2.3.2. They start on the rein as set in the starting list.

Sections:

1. any speed tölt
Return to walk and change rein.
2. any speed tölt

S2.8.8.3 Final round

The finalists show the required sections including rein changes as instructed by the speaker as described in S2.3.2.



S2.8.9 V1 – Four-gait test

This test is performed on the oval track.

S2.8.9.1 Eligible horses

Combinations starting in this class are excluded from other four- and five-gait tests at the same event.

S2.8.9.2 Preliminary Round

Riders compete individually. The test can be ridden on either rein.

The rider has four and a half rounds at his disposal to show the following gaits in any order:

1. slow tölt
2. slow to medium speed trot
3. medium walk
4. slow to medium speed canter
5. fast tölt

Each gait may be shown only once, walk for a half round and the other gaits for one round.

S2.8.9.3 Final Round

The finalists show the required sections as instructed by the speaker as described in S2.3.2.

The order will be as follows:

1. slow tölt
2. slow to medium speed trot
3. medium walk
4. slow to medium speed canter
5. fast tölt



S2.8.10 V2 - Four gait

S2.8.10.1 Eligible horses

Combinations starting in this test are excluded from other four- and five-gait tests at the same event.

S2.8.10.2 Preliminary Round

The test is ridden groups of up to three riders on the oval track. The horses show the four gaits as instructed by the speaker as described in S2.3.2. They ride on the rein as set in the starting list.

Sections:

1. slow tölt
2. slow to medium speed trot
3. medium walk
4. slow to medium speed canter
5. fast tölt

S2.8.10.3 Final Round

The finalists show the required sections as instructed by the speaker as described in S2.3.2.



S2.8.11 V3 – Four Gait

S2.8.11.1 Eligible horses

Combinations starting in this test are excluded from other four- and five-gait tests at the same event.

S2.8.11.2 Preliminary round

The test is ridden groups of up to five riders on the oval track. The horses show the gaits as instructed by the speaker as described in S2.3.2. They ride on the rein as set in the starting list.

Sections:

1. slow speed tölt
2. slow to medium speed trot
3. medium walk
4. slow to medium speed canter
5. medium to fast tölt

S2.8.11.3 Final round

The finalists show the required sections as instructed by the speaker as described in S2.3.2.



S2.8.12 V4 – Four Gait

S2.8.12.1 Eligible horses

Combinations starting in this test are excluded from other four- and five-gait tests at the same event.

S2.8.12.2 Preliminary round

The test is ridden groups of up to five riders on the oval track. The horses show the four gaits as instructed by the speaker as described in S2.3.2. They ride on the rein as set in the starting list.

Requirements:

1. medium walk
2. any speed tölt
3. transition of walk/tölt and tölt to walk, separately ridden as instructed by the speaker
Change rein
4. slow to medium speed trot
5. slow to medium speed canter; the start into canter and the stop after canter into walk is shown separately by each rider as instructed by the speaker

S2.8.12.3 Final round

The finalists show the required sections including rein changes as instructed by the speaker as described in S2.3.2.

S2.8.12.4 General remarks

The test is meant mostly to judge the style of riding and the seat of the rider and not mostly the gaits of the horse. What also matters is the harmony between rider and horse, the correctness of the performance and the obedience of the horse.

What is asked for:

Rider: Good seat, soft and sensitive handling of the reins, nearly invisible use of aids. Correct and quiet carrying out of the exercises, considerate behaviour towards the other riders.

The horse should be keen and relaxed in all gaits. Good composure, obedient in all exercises. Minor faults in the beat influence the marks only slightly as long as the riders' aids are correct. The highness and width of the horse's movements do not influence the marks awarded.



S2.8.13 V5 – Four Gait

S2.8.13.1 Eligible horses

Combinations starting in this test are excluded from other four- and five-gait tests at the same event.

S2.8.13.2 Preliminary Round

The test is ridden in groups of up to five riders on the oval track. The horses show the four gaits as instructed by the speaker as described in S2.3.2. They ride on the rein as set in the starting list.

Sections:

1. any speed tölt
2. slow to medium speed trot
3. medium walk
4. slow to medium speed canter

S2.8.13.3 Final Round

The finalists show the required sections as instructed by the speaker as described in S2.3.2.



S2.8.14 V6 – Four Gait

S2.8.14.1 Eligible horses

Combinations starting in this test are excluded from other four- and five-gait tests at the same event.

S2.8.14.2 Preliminary Round

The test is ridden in groups of up to five riders on the oval track. The horses show the four gaits as instructed by the speaker as described in S2.3.2. They ride on the rein as set in the starting list.

Sections:

1. any speed tölt
2. slow to medium speed trot
3. medium walk
4. slow to medium speed canter, the start into canter and the stop after canter into walk is shown separately by each rider as instructed by the speaker

S2.8.14.3 Final Round

The finalists show the required sections as instructed by the speaker as described in S2.3.2.



S2.8.15 F1 – Five-gait Test

This test is performed on an oval track with a minimum length of 250 m.

S2.8.15.1 Eligible horses

Combinations starting in this class are excluded from other four- and five-gait tests at the same event.

S2.8.15.2 Preliminary Round

Riders compete individually. The test can be ridden on either rein.

The rider has four and a half rounds at his disposal to show the following gaits in any order:

1. slow to medium speed tölt
2. slow to medium speed trot
3. medium walk
4. slow to medium speed canter
5. racing pace

Each gait may be shown only once, walk for a half round and the other gaits for one round.

The racing pace is shown on the long sides only.

The marks for tölt and pace will be doubled.

S2.8.15.3 Final Round

The finalists show the required sections as instructed by the speaker as described in S2.3.2.

The order will be as follows:

1. slow to medium speed tölt
2. slow to medium speed trot
3. medium walk
4. slow to medium speed canter
5. pace

The horses may show racing pace 3 times on one long side. The riders choose the long side by majority vote. In the event of a draw the vote of the preliminary round's winner is doubled. If this does not break the tie, the decision is made by a coin toss. If the coin lands "head" up the riders show pace in the direction selected by the Chief Judge before the coin is tossed.

The marks for tölt and pace will be doubled.



S2.8.16 F2 - Five gait

This test is performed on an oval track with a minimum length of 250m.

S2.8.16.1 Eligible horses

Combinations starting in this test are excluded from other four- and five-gait tests at the same event.

S2.8.16.2 Preliminary Round

The test is ridden groups of up to three riders on the oval track. The horses show the five gaits as instructed by the speaker as described in S2.3.2. They ride on the rein as set in the starting list.

Sections:

1. slow to medium speed tölt
2. slow to medium speed trot
3. medium walk
4. slow to medium speed canter
5. pace.

The horses may show racing pace 3 times on one long side. The riders choose the long side by majority vote. In the event of a draw a draw of lots by the speaker will decide. The marks for tölt and pace will be doubled.

S2.8.16.3 Final Round

The finalists show the required sections as instructed by the speaker as described in S2.3.2.

The horses may show racing pace 3 times on one long side. The riders choose the long side by majority vote. In the event of a draw the vote of the preliminary round's winner is doubled. The marks for tölt and pace will be doubled.



S2.8.17 F3 - Five gait

This test is performed on an oval track with a minimum length of 250m.

S2.8.17.1 Eligible horses

Combinations starting in this test are excluded from other four- and five-gait tests at the same event.

S2.8.17.2 Preliminary Round

The test is ridden groups of up to three riders on the oval track. The horses show the five gaits as instructed by the speaker as described in S2.3.2. They ride on the rein as set in the starting list.

Sections:

1. slow to medium speed tölt
2. slow to medium speed trot
3. medium walk
4. slow to medium speed canter
5. pace.

Pace is shown twice on one long side. The riders choose the long side by majority vote. In the event of a draw the speaker will decide. A combination needs to show one half of a long side to get a mark.

The mark for pace is doubled and the total number of points is divided by 6.

S2.8.17.3 Final Round

The finalists show the required sections as instructed by the speaker as described in S2.3.2.

Pace is shown twice on one long side. The riders choose the long side by majority vote. In the event of a draw the speaker will decide. A combination needs to show one half of a long side to get a mark.

The mark for pace is doubled and the total number of points is divided by 6.



S3 Pace track

S3.1 Restrictions

Whips are not allowed in the pace race, unless otherwise stated.

S3.2 Judges

A licensed FEIF Breeding (as listed on the FEIF website) or Gæðingakeppni judge (as listed on the Landssamband hestamannafélaga website) may be employed in any required position for pace track tests where the duties are limited to showing a flag to indicate whether a horse is in pace or not.

S3.3 Time keeping

Only the visual and not the acoustic signals are valid for time keeping.

The use of electronic time keeping equipment is mandatory for WorldRanking competitions and recommended for all other events.

The equipment and the way it is installed have to be approved by the chief judge of the specific event. When start boxes are used the time measuring shall begin when the doors start to open. (i.e. the electronic time keeping system should be connected to the opening system of the starting boxes.⁴)

Manual time keeping (as described below) can be performed as a backup to an electronic system. If the electronic system breaks down organizers must change to another system – manual or electronic. Times gained before the breakdown are still valid. A rider should never be allowed to make more than one extra sprint to gain valid times.

Manual Time Keeping Procedure

When no electronic time keeping equipment is used each rider should be timed with three watches. The average time between those two times closest to one another will count. If all three watches show the same interval to one another, the average time of those three times will count. The average time will always be rounded to two decimal places, following the common mathematical rules. The same goes for marks derived from times.

One judge at the finishing line is also in charge of the time keeping: He is responsible for:

- quiet and uninterrupted working conditions for the persons responsible for time keeping;
- clear instructions as to who is responsible for timing which horse;
- allowing the start, when the time keeping is ready.

Judges at the finishing line may not be involved in time keeping at the same time.

To make times comparable between different events, 0.40 seconds will be added to any hand stopped time before publishing times and calculating marks.

⁴ The Sport Committee may distribute instructions about the use of electronic time keeping equipment.



S3.4 Scoring in races

In races with more than one run, the fastest run will be marked. The marks are based on the horses' recorded time in accordance with appropriate the time/marks conversion, to two decimal places. If times are equal, the second best time of the horses will decide on the placing and so on. In the case of equal times for the first place in all runs, these horses shall run an extra race, and the judges shall show the final positions.

If a horse falls out of racing pace between the 50 m marker and the finishing line, the run concerned will not be marked.

S3.5 Records

For a record time to be recognised by FEIF, the following conditions must be met:

- the track must meet the requirements described in the FEIF Rules and Regulations
- the use of start boxes is required in P1 and P3
- the use of electronic time keeping equipment is required
- in P1 and P3 the time keeping starts running when the doors of the start boxes start to open
- in P1 and P3 the finish has to be filmed with video equipment connected to the time keeping system, able to distinguish between riders
- the wind speed in the direction of the race must not exceed a speed of 5.4 m/s and should be measured with a wind gauge meeting the requirements set by the FEIF Sport Committee located at the side of the track
- the rider must have adhered to the racing rules



S3.6 Test Descriptions

S3.6.1 P1 – Pace Race 250 m

This test is performed on the pace track, in two or more heats.

S3.6.1.1 Eligible Horses

Combinations starting in this race are excluded from P3 at the same event.

S3.6.1.2 Starting boxes

When start boxes are used they should meet the requirements set and published by the Sport Committee. The requirements include a definition of the starting line and the way electronic time keeping equipment has to be connected to the start boxes.

S3.6.1.3 Withdrawal from heats

If a rider wants to withdraw from a heat, he has to inform the secretariat before the relevant heat is going to start.

Withdrawal after this time limit will only be accepted if the horse or rider is declared unfit by a veterinary surgeon or a doctor; otherwise the horse is disqualified from the test in question.

S3.6.1.4 Start

Up to four horses proceed to the start. In case of disagreement in the first run, the judge at the start decides about the starting places. All riders are marked with distinct colours. Any rider may have two helpers. Helpers should wear an approved helmet and no whips are allowed. If the start has not been declared after 10 minutes, the horse preventing the start from taking place must move back a few steps. If after a further 5 minutes the start has not been declared because of the same horse, the horse will be eliminated from that heat. The ready-to-start must be declared by the judge standing on the finishing line, holding the starting flag up in the middle of the track at a level with the finishing line. At the starter's signal, the riders ride to the 50 m marker in any gait they wish. From there to the finish the horse must be in racing pace. There will be two or four runs all in all, but not more than two per day.

S3.6.1.5 Start with start boxes or automated starting machines

When starting boxes or automated starting machines are used all riders are allowed 2.0 minutes to bring their horses into a start box; the start should be performed not later than 30 seconds after the last horse has entered its start box. If a rider doesn't succeed within this time limit, he is eliminated from the specific run.

Helpers are not allowed to leave the ground; they have to have at least one foot on the ground, without exception. If the helpers don't meet the requirements, the rider is eliminated.

One extra judge is allocated to supervise the starting procedure behind the starting line.



S3.6.1.6 Starting order

Before the first run, lots are drawn in order to set the starting order. In the second to the fourth run, those riders start together who's finishing times in the previous heat were nearest to one another. This means that the first starting group will be composed of the up to then slowest horses, the second group of the second slowest etc. If equal starting groups cannot be formed, the slowest group always starts with less horses, if necessary individually. If several horses are not rated, allocation of the horses to the starting groups will be decided by drawing lots.

The rider in the fastest (last) position in a starting group has to decide before the start group is called into the start boxes (or at the starting line) which box (or position) the rider prefers, with no right of change the moment the starting procedure has started. At the starting line the horse must stand quietly, straight and in the direction of the finish. Other starting positions can be allowed (e.g. horse standing diagonally), if the rider informs the other riders of his starting group and is allowed by the starter to do so. If a horse was obstructed at the start and could not start for this reason, the starter can allow it to start alone. This will not count as a false start. As soon as all horses are standing still and in the direction of the finish, the start can be signalled. The starter should stand on some sort of elevation about 3 m outside the track and one to two meters in front of the riders. He gives a visual signal (two-coloured flag if possible) and an acoustic (voice) signal.

The meaning is as follows:

- Flag raised: attention, start can be any time
- Flag lowered: go !

S3.6.1.7 Judges

Nine judges are needed.

A minimum of five judges is required at WorldRanking events. The other positions may be filled using pace assistants.

Pace assistants should be properly trained and approved by their national association:

- one judge stands at the starting line;
- judge two and three or one judge and a pace assistant stand at the 50 m mark on each side of the track;
- the fourth judge or pace assistant stands between the 50 m and 100 m marker;
- the fifth judge or pace assistant stands between the 100 m and 150 m marker;
- the sixth judge or pace assistant stands between the 150 m and 200 m marker;
- the seventh judge or pace assistant stands between the 200 m and 250 m marker;
- judge eight and nine or one judge and a pace assistant stand at the finishing line on each side of the track.

When start boxes are used one extra judge or pace assistant is needed to supervise the starting procedure behind the starting line. The judges or pace assistants have coloured flags in the same colours as the riders. If elimination is necessary, the judge or pace assistant will show the relevant colour, if the horse's run is OK, he will show a white flag.

S3.6.1.8 Riders

Each rider must be clearly identifiable.

Active leg aids are allowed in the race. Any aids to urge the horse to go faster, which could distract the other riders taking part, are forbidden. If a rider obstructs other riders, his horse's time will not count. Horses waiting for the next heat must stand at least 30 m behind the finishing line.



Upon request, the Chief Judge can allow a horse that has been distracted to have an extra start alone.

S3.6.1.9 Electronic Timekeeping

If the electronic timekeeping system cannot provide a time for the second-place horse in a sprint the following table is used to calculate the time based on the first horse's time and the distance between the two horses at the finish line.

End Time	0.5m ⁵	1.0m ⁶	1.5m ⁷	2.0m	2.5m	3.0m
21.0 – 22.9	0.04	0.08	0.12	0.16	0.20	0.24
23.0 – 24.9	0.05	0.09	0.14	0.18	0.23	0.27
25.0 – 26.9	0.05	0.10	0.15	0.20	0.25	0.30
27.0 – 28.9	0.06	0.11	0.17	0.22	0.28	0.33
29.0 – 31.0	0.06	0.12	0.18	0.24	0.30	0.36

S3.6.1.10 Marks

The marks for any time are calculated with the following formula:

$$(32.50 - t) / 1.25$$

where t = the time of the fastest run in the appropriate number of decimals

Marks cannot be higher than 10.00 or lower than 0.00.

Rounding of marks is done according to the rules described in S2.2.

⁵ Approximately the length of the head.

⁶ Approximately the length of the head and neck.

⁷ Approximately half a horse length.



S3.6.2 P2 – SpeedPass: Pace race 100 m with flying start

This test is conducted on a pace track, where should be at least a stretch of 50 m before the start of the timed stretch of 100 m.

S3.6.2.1 Start

One horse at a time proceeds to the start. At the starters' signal, the rider rides to the 50 m marker in any gait he wishes. On crossing the 50 m mark, time keeping starts at a visual signal. From there to the finish line the horse must be in racing pace. There will be two runs.

S3.6.2.2 Starting order

Before the first run, lots are drawn to set the starting order. In the second run the starting order is set by the rating in the first run. The slowest horse(s) will start first.

S3.6.2.3 Judges

Four judges are needed.

- judge 1 at the starting line;
- judge 2 between the 0m and 50m marks;
- judge 3 between the 50m and 100m marks;
- judge 4 at the finish line

S3.6.2.4 Scoring

The fastest run will be marked. If times are equal, the second best time of the horses will decide on the placing and so on. If a horse falls out of racing pace between the 50 m marker and the finishing line, the run concerned will not be marked.

S3.6.2.5 Equipment

The use of an approved whip is allowed.

S3.6.2.6 Riders

See P1 – Pace race 250 m.

S3.6.2.7 Marks

The marks for any time are calculated with the following formula:

$$(12.00 - t) / 0.60$$

where *t* = the time of the fastest run in the appropriate number of decimals

Marks cannot be higher than 10.00 or lower than 0.00.

Rounding of marks is done according to the rules described in S2.2.



S3.6.3 P3 - Pace race 150 m

This test is conducted in the same way as P1 - Pace race 250m except as noted below.

S3.6.3.1 Eligible Horses

Combinations starting in this race are excluded from P1 at the same event.

S3.6.3.2 Judges

Seven judges are needed.

A minimum of five judges is required at WorldRanking events. The other positions may be filled using pace assistants.

Pace assistants should be properly trained and approved by their national association:

- one judge stands at the starting line;
- judge two and three or one judge and a pace assistant stand at the 50 m mark on each side of the track;
- the fourth judge or pace assistant stands between the 50 m and 100 m marker;
- the fifth judge or pace assistant stands between the 100 m and 150 m marker;
- judge six and seven or one judge and a pace assistant stand at the finishing line on each side of the track.

When start boxes are used one extra judge or pace assistant is needed to supervise the starting procedure behind the starting line. The judges or pace assistants have coloured flags in the same colours as the riders. If elimination is necessary, the judge or pace assistant will show the relevant colour, if the horse's run is OK, he will show a white flag.

S3.6.3.3 Electronic Timekeeping

If the electronic timekeeping system cannot provide a time for the second-place horse in a sprint the following table is used to calculate the time based on the first horse's time and the distance between the two horses at the finish line.

End Time	0.5m ⁸	1.0m ⁹	1.5m ¹⁰	2.0m	2.5m	3.0m
13.5 – 14.4	0.04	0.08	0.12	0.16	0.20	0.24
14.5 – 15.4	0.05	0.09	0.14	0.18	0.23	0.27
15.5 – 16.4	0.05	0.10	0.15	0.20	0.25	0.30
16.5 – 17.4	0.06	0.11	0.17	0.22	0.28	0.33
17.5 – 18.9	0.06	0.12	0.18	0.24	0.30	0.36
19.0 – 20.9	0.07	0.13	0.20	0.26	0.33	0.39
21.0 – 23.0	0.07	0.14	0.21	0.28	0.35	0.42

S3.6.3.4 Marks

The marks for any time are calculated with the following formula:

$$22.00 - t$$

where t = the time of the fastest run in the appropriate number of decimals

Marks cannot be higher than 10.00 or lower than 0.00. Rounding of marks is done according to the rules described in S2.2.

⁸ Approximately the length of the head.

⁹ Approximately the length of the head and neck.

¹⁰ Approximately half a horse length.



S3.6.4 PP1 – Pace Test

S3.6.4.1 Eligible Horses

Combinations starting in this race are excluded from PP2 at the same event.

S3.6.4.2 Track

This test is performed on a track suitable for pace tests. Please refer to the drawing enclosed.

S3.6.4.3 Starting order

Before the first run, lots are drawn to set the starting order. The starting order is the same in the first and the second run.

S3.6.4.4 Start

As soon as the starting flag is raised, the horse moves off at walk, trot or tölt. Between the starting line and the 25 m mark, strike off in canter from any gait. Between the 25 m mark and the 50 m mark (beginning of the timed stretch) change into racing pace. On crossing the 50 m mark time keeping starts at a visual signal. After the 150 m mark (end of the timed stretch) and before the end marker at 200 m, the horse has to have returned to tölt, trot or walk. For high marks the horse shall have returned to walk.

At the beginning of the track (up to the 25 m mark), there must be a clearly marked funnel-shaped corridor according to the drawing.

The average of the marks of two runs decides the placing. In case of equal marks the marks given by the judges will decide the winner. In case the marks for the first place are equal a tie break has to be performed.

S3.6.4.5 Judging

Six judges are needed; they score openly from 0-10 with half points:

- the first judge judges the strike off at canter and the changeover into pace;
- the second judge judges the pace between the 50 m and 100 m mark;
- the third judge judges the pace between the 100 m and 150 m mark;
- the fourth judge judges the downward transition between the 150 m marker and the end of the track at 200 m;
- the starter (who must be a judge) stands at the 50 m mark and indicates to the three timekeepers at the 150 m mark with the flag that the horse has passed the 50 m mark. The starter also indicates with a red flag if the horse is not in pace at the 50 m mark;
- At the 150 m mark a judge will show a red flag if the horse is not in pace when crossing the 150 m line.

The judges choose their places in order to get the best possible view over their respective areas. When the horse has passed the area concerned, judges one to four show their marks. If the horse falls out of pace during the timed section, the relevant judge(s) show(s) a red flag and no marks for time shall be given.

A maximum of 40 points for style and a maximum of 20 points for time can be obtained according to the table of marks. The final sum is to be divided by 6.



S3.6.4.6 Announcement of Marks

The speaker shall announce the marks and time in order of judging positions with the rider's time announced before the mark for slowing down.

S3.6.4.7 No Time

If a horse gets the mark 0 from judge 2 or 3 and/or a red flag from the judge at the starting line or the judge at the finishing line, there will be given no scores for the time.

S3.6.4.8 Table of Marks

The marks for any time in seconds are calculated using the following table.

Time	Mark	9.3	13.5	10.7	6.5
8.0 or faster	20.0	9.4	13.0	10.8	6.0
8.1	19.5	9.5	12.5	10.9	5.5
8.2	19.0	9.6	12.0	11.0	5.0
8.3	18.5	9.7	11.5	11.1	4.5
8.4	18.0	9.8	11.0	11.2	4.0
8.5	17.5	9.9	10.5	11.3	3.5
8.6	17.0	10.0	10.0	11.4	3.0
8.7	16.5	10.1	9.5	11.5	2.5
8.8	16.0	10.2	9.0	11.6	2.0
8.9	15.5	10.3	8.5	11.7	1.5
9.0	15.0	10.4	8.0	11.8	1.0
9.1	14.5	10.5	7.5	11.9	0.5
9.2	14.0	10.6	7.0	12.0 or slower	0.0



S3.6.5 PP2 – Pace Test

S3.6.5.1 Eligible Horses

Combinations starting in this race are excluded from PP1 at the same event.

S3.6.5.2 Track

This test is performed on a track suitable for pace tests. Please refer to the drawing enclosed.

S3.6.5.3 Starting order

Before the first run, lots are drawn to set the starting order. The starting order is the same in second run.

S3.6.5.4 Start

As soon as the starting flag is raised, the horse moves off at walk, trot or tölt. Between the starting line and the 25 m mark, strike off in canter from any gait. Between the 25 m mark and the 50 m mark (beginning of the timed stretch) change into racing pace. On crossing the 50 m mark time keeping starts at a visual signal. After the 150 m mark (end of the timed stretch) and before the end marker at 200 m, the horse has to have returned to tölt, trot or walk. For high marks the horse shall have returned to walk.

At the beginning of the track (up to the 25 m mark), there must be a clearly marked funnel-shaped corridor according to the drawing.

Horses are allowed to have two runs (even if they receive red flags). The average of the marks of both runs decides the placing. In case of equal marks the marks given by the judges will decide the winner. In case the marks for the first place are equal a tie break has to be performed.

S3.6.5.5 Judging

Six judges are needed; they score openly from 0-10 with half points:

- the first judge judges the strike off at canter and the changeover into pace;
- the second judge judges the pace between the 50 m and 100 m mark;
- the third judge judges the pace between the 100 m and 150 m mark;
- the fourth judge judges the downward transition between the 150 m marker and the end of the track at 200 m;
- the starter (who must be a judge) stands at the 50 m mark and indicates to the three timekeepers at the 150 m mark with the flag that the horse has passed the 50 m mark. The starter also indicates with a red flag if the horse is not in pace at the 50 m mark;
- At the 150 m mark a judge will show a red flag if the horse is not in pace when crossing the 150 m line.

The judges choose their places in order to get the best possible view over their respective areas. When the horse has passed the area concerned, judges one to four show their marks. If the horse falls out of pace during the timed section, the relevant judge(s) show(s) a red flag and no marks for time shall be given.

A maximum of 40 points for style and a maximum of 10 points for time can be obtained according to the table of marks. The final sum is to be divided by 5.



S3.6.5.6 Announcement of Marks

The speaker shall announce the marks and time in order of judging positions with the rider's time announced before the mark for slowing down.

S3.6.5.7 Marks

If a horse gets the mark 0 from judge 2 or 3 and/or a red flag from the judge at the starting line or the judge at the finishing line, there will be given no scores for the time. However the run will be valid.

S3.6.5.8 Table of Marks

The marks for any time in seconds are calculated using the following table.

Time	Mark	Time	Mark	Time	Mark
9.0 or faster	10.00	10.4	6.50	11.8	3.00
9.1	9.75	10.5	6.25	11.9	2.75
9.2	9.50	10.6	6.00	12.0	2.50
9.3	9.25	10.7	5.75	12.1	2.25
9.4	9.00	10.8	5.50	12.2	2.00
9.5	8.75	10.9	5.25	12.3	1.75
9.6	8.50	11.0	5.00	12.4	1.50
9.7	8.25	11.1	4.75	12.5	1.25
9.8	8.00	11.2	4.50	12.6	1.00
9.9	7.75	11.3	4.25	12.7	0.75
10.0	7.50	11.4	4.00	12.8	0.50
10.1	7.25	11.5	3.75	12.9	0.25
10.2	7.00	11.6	3.50	13.0 or slower	0.00
10.3	6.75	11.7	3.25		



S4 Dressage tests

S4.1 Dressage arena

The dressage arena must be 20 x 40 m or 20 x 60 m, and be marked with the proper signs shown in the drawings in S16.5. In case of a 20 x 60 m arena, only the marks A, F, B, M, C, H, E and K will be used on the outside of the track. Organisers are allowed to mark the middle of the distance between F-B, B-M, K-E and E-H with an extra mark, for instance a dot.

S4.2 Judges

Three judges score individually.

S4.3 Test Descriptions

S4.3.1 FS1 - Free Style Performance

S4.3.1.1 Requirements

Number of elements minimum 10, maximum 14.

The program of the test shall be created by the rider. The test is to be submitted in writing on the required forms before the start of the competition to the competition secretary.

S4.3.1.2 Minimum demands

- medium walk
- tölt
- slow or medium speed canter
- transitions of the gaits and speed
- change of rein
- bending
- halt
- salute

Possible elements besides the minimum demands

- trot
- leg yielding or shoulder in
- rein back
- turn on the haunches
- change of canter via walk, trot or tölt.

Any test element will only be rated once per rein. The salute is an exception.

S4.3.1.3 Music

Suitable music is to be provided by the rider. Multiple pieces of music are only allowed when a representative of the rider is available to play the music in the right order on the equipment provided by the organiser of the competition.



S4.3.1.4 Scoring

3 Judges score individually and separately.

The individual test elements as well as the general impression (divided into: 1. regularity of the gaits, 2. impulsion, 3. obedience, 4. seat and use of aids) will be judged with a scale of marks from 0.0 to 10.0 (inclusive) with half points. There are no separate marks for the music (but music is obligatory).

When getting zero for one or more individual test movements, points will be deducted from the sum of the marks in the following manner:

- 1st zero 3 points
- 2nd zero 8 points (total: 11)
- 3rd zero 17 points (total: 28)
- 4th zero elimination

The total to be reached consists of the sum of the marks for the individual test elements plus the four marks for the general impression minus deductions divided by the number of individual test elements plus four, thus ranging from 0.0 to 10.0 (inclusive), rounded to one decimal.

In case of equal marks for the first place, the judges shall show the final ranking.



S4.3.2 FS2 - Riding in the dressage arena

S4.3.2.1 Requirements

Number of elements minimum 8, maximum 12. Length of test about 5 minutes.

The rider shall create the program of the test. The test (including diagrams) is to be submitted in writing on the required forms before the start of the competition to the competition secretary. The ridden dressage elements should be chosen out of the following examples:

- halt from walking and/or trot/tölt
- move off into walk and/or trot/tölt
- serpentine loops, circle change of rein from circle to circle - walk, trot or tölt
- figure of eight in walk or trot/tölt
- canter right and left around the outside/or circle
- turn on the forehand
- leg-yielding (walk) at any place
- change of gait (tölt-trot-tölt) at any place

Each element can only be shown once (exception: canter right and left, leg-yielding right and left, turn on the forehand right/left).

S4.3.2.2 Music

Suitable music is to be provided by the rider on cassette or on CD. More than one cassette or more than one CD is only allowed when a representative of the rider is available to play the music in the right order on the equipment provided by the organiser of the competition.

S4.3.2.3 Judging

3 Judges score individually and separately.

The individual test elements as well as the general impression (divided into: 1. regularity of the gaits, 2. impulsion, 3. obedience, 4. seat and use of aids) will be judged with a scale of marks from 0.0 to 10.0 (inclusive) with half points. There are no separate marks for the music (but music is obligatory).

When getting zero for one or more individual test movements, points will be deducted from the sum of the marks in the following manner:

- 1st zero 3 points
- 2nd zero 8 points (total: 11)
- 3rd zero 17 points (total: 28)
- 4th zero elimination

The total to be reached consists of the sum of the marks for the individual test elements plus the four marks for the general impression minus deductions divided by the number of individual test elements plus four, thus ranging from 0.0 to 10.0 (inclusive), rounded to one decimal.

In case of equal marks for the first place, the judges shall show the final ranking.



S4.3.3 FS3 - In-hand showing in the dressage arena

Free choice of presentation. The horse is shown from the ground.

S4.3.3.1 Requirements

Number of elements minimum 5, maximum 8. Length of test about 5 minutes.

The program of the test shall be created by the rider. The test (including diagrams) is to be submitted in writing on the required forms before the start of the competition to the competition secretary.

Possible elements:

- training on the ground
- lunging the horse
- lunging with 2 reins
- free dressage "from the ground"
- driving from the ground
- long reins
- without reins or lunge contact

Other elements which can be done without riding the horse are allowed.

S4.3.3.2 Restrictions

It is allowed to show the horse without any equipment. Clothing of the rider should correspond with the test.

S4.3.3.3 Music

Suitable music is to be provided by the rider on cassette or on CD. More than one cassette or more than one CD is only allowed when a representative of the rider is available to play the music in the right order on the equipment provided by the organiser of the competition.

S4.3.3.4 Judging

3 Judges score individually and separately.

The individual test elements as well as

- handling of the horse,
- harmony,
- idea and presentation,
- use of aids

will be judged with a scale of marks from 0.0 to 10.0 (inclusive) with half points. There are no separate marks for the music (but music is obligatory).

When getting zero for one or more individual test elements, points will be deducted from the sum of the marks in the following manner:

- 1st zero 3 points
- 2nd zero 8 points (total: 11)
- 3rd zero 17 points (total: 28)
- 4th zero elimination

The total to be reached consists of the sum of the marks for the individual test elements plus the four marks for the general impression minus deductions divided by the number of individual test elements plus four, thus ranging from 0.0 to 10.0 (inclusive), rounded to one decimal.

In case of equal marks for the first place, the judges shall show the final ranking.



S5 Figures Tests

S5.1 Dressage arena

The dressage arena must be 20 x 40m or 20 x 60m. Side markers should include A, B, C, E, F, H, K and M.

The arena should be marked according to dashed lines in the diagrams included with the descriptions of the tests. The marking should be made with paint or chalk dust.

The large circles at “A” and “C” are 14m in diameter.

The small circles at “A” and “C” in FG2 are 10m in diameter.

The small circles at “B” and “E” in FG3 are 8m in diameter.

S5.2 Judges

Three judges score individually. Marks are given according to S2.2.1.

S5.3 Music

Riders are permitted to select their own music. The volume of the music is determined by the chief judge of the test.

S5.4 Eligible horses

Combinations may only start in one Figures test at the same event.

S5.5 Boots & Protective Equipment

Boots and leg protective equipment are not allowed on the horse.



S5.6 Test Descriptions

S5.6.1 FG1 – Level 1

The rider has one minute to proceed, by any route, to A to begin the test. The rider may start the test on either rein.

Elements:

1. The rider begins in slow to medium tempo tölt (or trot) and nods at A to begin the test. The rider completes one Figure 8 keeping an even rhythm (beat and speed) throughout the entire figure.
2. The rider executes a circle at A in any speed tölt (or trot). The rider crosses the diagonal and executes a second circle at C. The rider crosses the diagonal again to finish the element at A. The rider must keep an even rhythm (beat and speed) throughout the entire element.
3. The rider makes a transition to walk and rides across the diagonal in a relaxed, but still energetic walk with rein contact. At C, the rider halts for three seconds and nods to indicate the end of the test.

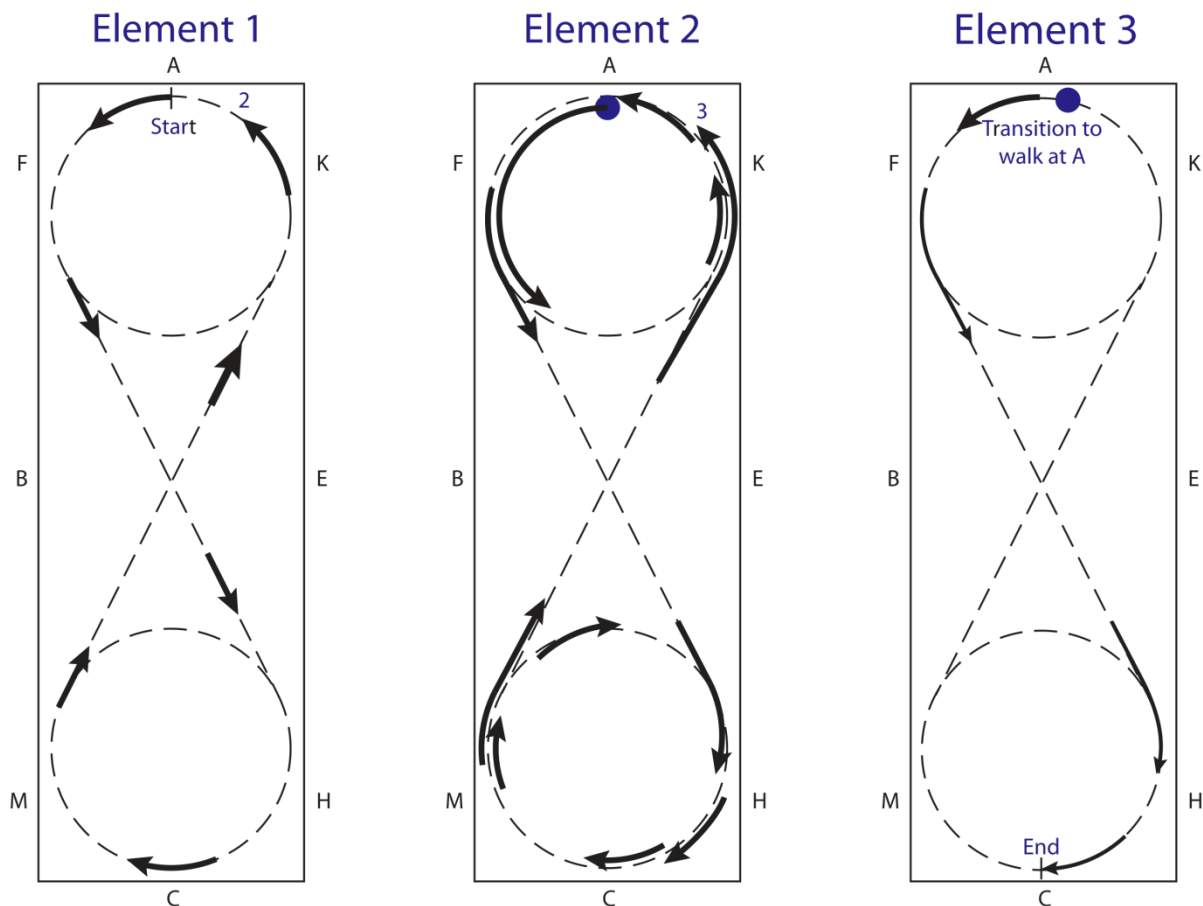

S5.6.2 FG2 – Level 2

The rider has one minute to proceed, by any route, to A to begin the test. The rider may start the test on either rein.

Elements:

1. The rider begins in slow to medium tempo tölt and nods at A to begin the test. The rider completes one Figure 8 keeping an even rhythm (beat and speed) throughout the entire figure.
2. The rider executes a 10m circle at A in any speed tölt. The rider crosses the diagonal and executes a second 10m circle at C. The rider must keep an even rhythm (beat and speed) throughout the entire element.
3. At C, the rider continues in slow tölt. The rider increases speed as he starts to cross the diagonal. At X, the rider begins to decrease to slow tölt and continues to A. The rider repeats the speed change across the opposite diagonal. Approaching C, the rider transitions to walk and halts for three seconds at C nodding to indicate the end of the test.

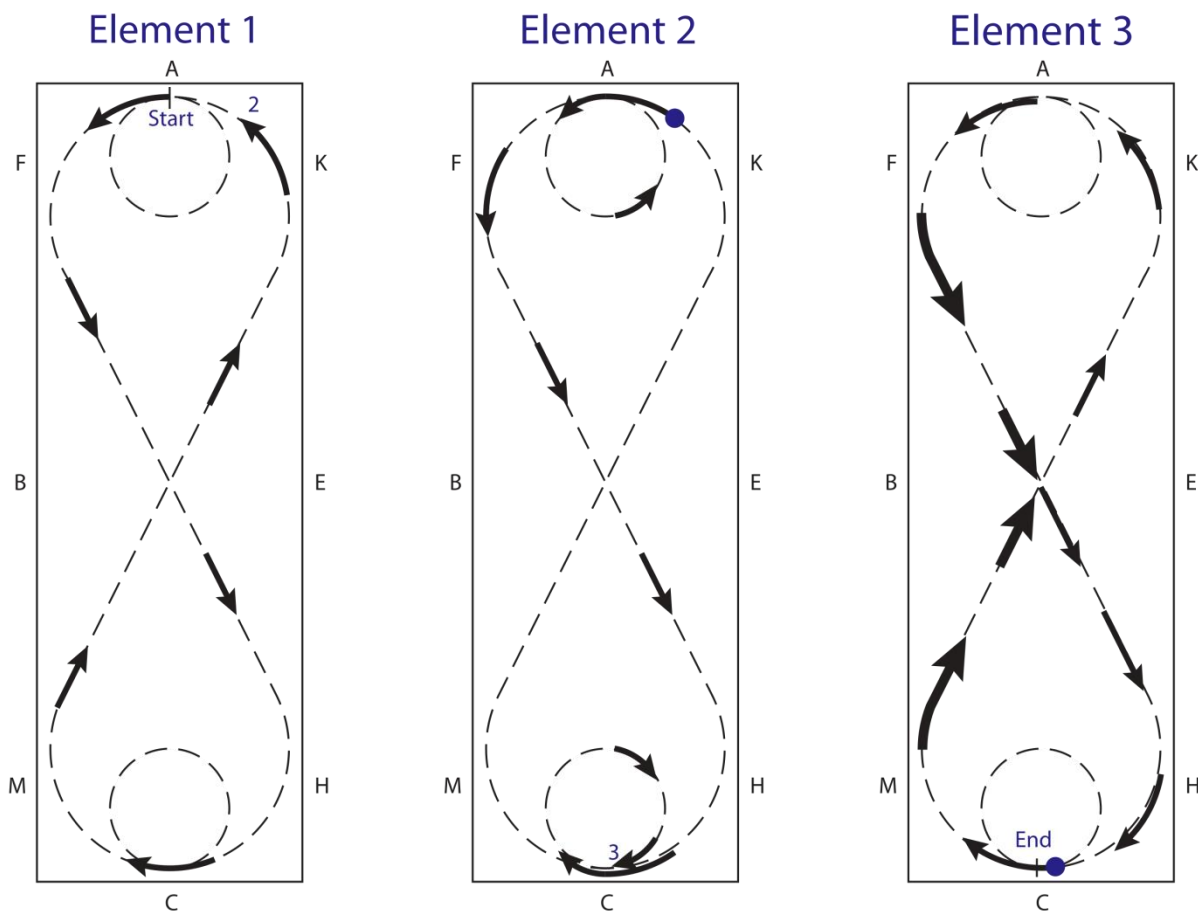

S5.6.3 FG3 – Level 3

The rider has one minute to proceed, by any route, to A to begin the test. The rider may start the test on either rein.

Elements:

1. The rider begins in slow to medium tempo tölt and nods at A to begin the test. The rider completes one Figure 8 keeping an even rhythm (beat and speed) throughout the entire figure.
2. The rider executes two 8m circles at B or E in any speed tölt. The rider crosses X and executes two more 8m circles. The rider continues across the diagonal to C to complete the element. The rider must keep an even rhythm (beat and speed) throughout the entire element.
3. At C, the rider continues in slow tölt. The rider increases speed as he starts to cross the diagonal. At X, the rider begins to decrease to slow tölt and continues to A. The rider repeats the speed change across the opposite diagonal. Approaching C, the rider transitions to walk and halts for three seconds at C nodding to indicate the end of the test.

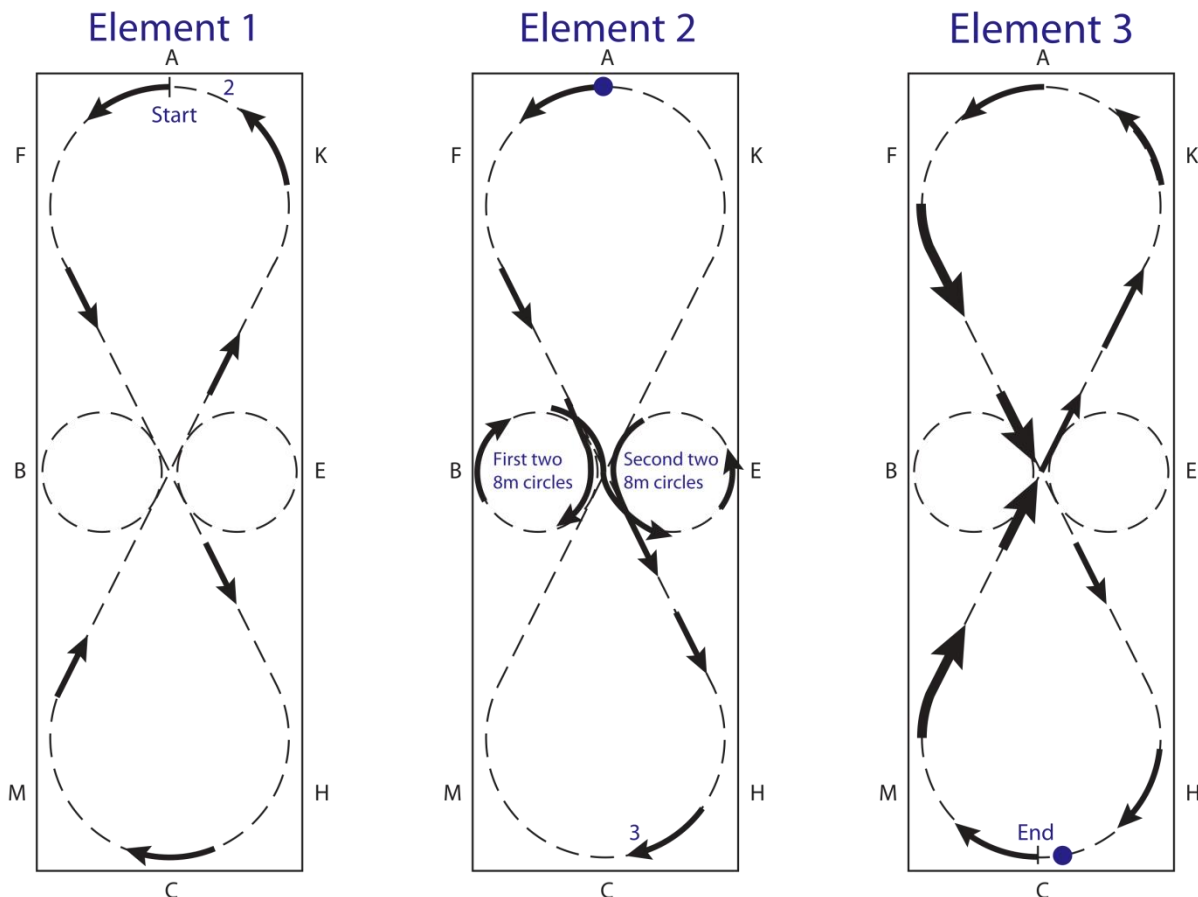

S6 Other tests

S6.1 FR1 – Flag race

S6.1.1 Track

The test is conducted on a pace track of 200 m. When needed, an oval track may be used.

The start line and finish line should be clearly marked. An even number of buckets filled with sand standing on a barrel must be available on the track. Before the start of any rider, a flag on a pole should be placed in every odd bucket (1/3/5 ...). It must be easy to take the flag out of a bucket and to put it back in the next bucket (2/4/6 ...).

S6.1.2 Starting order

Before the first run, lots are drawn to set the starting order. The starting order is the same in the first and second run. Every combination is entitled to two runs. However, only the best run counts.

S6.1.3 Start

Only one horse at the start at the time. After an acoustic and visible signal given by the starter (who must be a judge), the horse starts in a free gait. At every odd bucket (1/3/5 ...) the rider takes the flag out of the bucket and puts it back in the next bucket (2/4/6 ...). After the last bucket the horse passes the finish line. The visible signal indicates to the three timekeepers at the finish line that the horse has started.

S6.1.4 Judging

A judge monitors every pair of buckets. If a flag falls out of a bucket during the test after being placed into the right bucket, 15 penalty seconds are added to the time of the specific run.

S6.1.5 No Mark

If a rider makes a turn or fails to put a flag into the right bucket, the run is marked zero.



S6.2 TR1 – Trail

S6.2.1 Track

The test is conducted in a suitable area. No element should have such hazard to cause danger to horse or rider. A test should have at least 5 elements.

S6.2.2 Start

Only one horse at the start at a time. Up to three horses are allowed in the track at the time.

S6.2.3 Judging

The judges use a scale of marks from 0.0 to 10.0 (inclusive), with half points for each required section. The final mark is the arrhythmic mean of all sections. All final marks are rounded to one decimal following the common arrhythmic rules.

S6.2.4 Requirements

The following elements could be included:

- Open gate from horseback, go through and shut it
- Poles on the ground, the horse must step over them
- Water - must be ridden through
- Bridge (min. width 90 cm, min. length 1,50 m) must be ridden over
- Circle of sawdust (diameter around 5 m), let the horse wait in the circle, the rider must go outside around it (ground tying)
- Poncho or something like it - placed on a pole: take it from one side, ride at least 5 m and put it down the other side
- Barrel, ride in slalom in tölt or trot
- Leading of the horse
- Mount and dismount horse
- Walk with loose reins - min. 40 m
- Canter - min. 100 m on one rein, no sharp bends
- Load into a trailer - the trailer must be of a solid construction with a non-slippery floor. The horse must be led into the trailer and stand there min. 10 sec. quiet, unloading
- Gate with ribbons (width 90 cm, height around 1,90 m) must be ridden through/ridden under
- Step backwards - out of a lane of poles (about 5 m long)
- Seesaw/"Wippe" (min. width 90 cm, min. length 1,50 m) must be ridden over
- Labyrinth of poles lying on the ground - must be ridden through in walk
- Drag something along (e.g. a filled sack)
- Riding through a narrow gap in a wall or fence
- Polo over a certain distance
- Softball transport (min. 5 balls)
- Super slalom around 4 poles, distance of 80 cm to 1 m / 4 m width
- Slalom around barrels without touching reins

Additional tests, suitable for Icelandic horses, can be added.



S6.3 CR1 – Countryside riding

S6.3.1 Start

Only one horse at the start at the time.

S6.3.2 Judging

The judges use a scale of marks from 0.0 to 10.0 (inclusive), with half points for each required section.

If there are timed sections, the fastest combination (after adding penalty seconds) gets a mark of 6.0. Every next combination will be marked with 0.2 less, so the second combination will get 5.8, the third 5.6 and so on. However, the lowest mark possible is 0.0.

The final mark is the arrhythmic mean of all sections. All marks are rounded to one decimal following the common arrhythmic rules.

S6.3.3 Requirements

The length of the test and the test itself depends on the local possibilities. The difficulty of the trail used should not exceed the standards for normal countryside riding. It is allowed to dismount the horse.

The following elements can be included:

- uphill - downhill, the requirements can have different difficulties
- canter on right/left rein
- racing canter (in a timed stretch)
- jumping fences (e.g. a log), also easier possibilities, max. height 60 cm
- passing special situations (e.g. a tractor)
- narrow passages
- riding through water
- riding different gaits in different stretches

S6.3.4 General remarks

Length of test: 15 to 50 minutes. The test is conducted in the countryside.

The main emphasis should be the harmony between horse and rider and also the rider's handling of the horse when passing difficult situations which could happen while riding in the countryside.



S7 World Championships

S7.1 Teams

A national sport team can comprise of up to 7 rider/horse combinations and a reserve horse, a reserve rider or a reserve rider/horse combination. In addition, up to five extra eligible rider/horse combinations and a reserve horse, a reserve rider or a reserve rider/horse combination can be added to the team, provided that the extra riders are at least 16 years old and not more than 21 years old in the calendar year. (see 2.1.4 Eligibility of riders)

Riders can be divided in two age classes: Young Riders and other riders (adult class). Any rider at least 16 years old and not more than 21 years old in the calendar year has to decide before the start of the World Championships in which class he/she will participate. There is no right of change after the final registration of teams at the World Championships.

Only one horse per rider is allowed in the World Championships sport competitions. The rider/horse combination cannot be changed after the final entry. Excepted from this is when the reserve is entered in accordance with the rules.

If a competitor or his horse suffers from illness and/or an accident, this competitor and/or another competitor from the same age class and/or horse may replace the horse formally entered. This is allowed up to one hour before start of the test and only upon producing a certificate from a doctor/veterinary surgeon who has examined the horse on site and only upon approval of the Chief Judge. This replacement is valid only if the original rider and/or horse have not started in any test yet.

The reserve combination may select its own disciplines. Where these differ from those of the original combination, the reserve will start as number one.

The reigning World Champions are allowed to participate at the succeeding World Championships with the same or another eligible horse. They must be officially entered by their national organisation but will start in addition to the national team in the same team uniform. They are allowed to start in any discipline.

S7.2 Horses

S7.2.1 Eligible horses

Horses that comply with the specific rule about eligible horses in the FEIF General Rules, and that are 6 years or older in the calendar year, are eligible.

S7.2.2 Shoeing

Current FEIF General and Sport Rules apply. The Chief Judge and specially appointed judges take care of the shoeing check during the World Championships.

At World Championships the shoeing of all horses participating must be examined and checked, preferably the day before the start of the first test or assessment and not earlier than the second to last day before.

S7.2.3 Inspections

Current FEIF General and Sport Rules apply. The FEIF Director of Sport shall approve the Ring Stewards for the equipment inspections.



S7.3 Riders

S7.3.1 Eligible riders

Riders that comply with the specific rule about eligible riders in the FEIF General Rules, and which are 16 years or older in the calendar year are eligible. A rider must have the nationality of the country he is representing or have had his permanent residence in the country he is representing for at least the previous year (counted back from the first day of World Championships).

S7.3.2 Riders' dress/equipment

Riders should wear a riding jacket, riding breeches or jodhpurs, and riding boots or Jodhpur boots. In pace race and pace test a riding jacket can be replaced by another appropriate garment. Each national team must be uniformly dressed when riding in the competitions or parades.

S7.4 Judges

S7.4.1 Chief Judge

A Chief Judge is appointed by the Board of FEIF upon recommendation by the Sport Committee at least 10 months before the start of the World Championships. At the same time a Deputy Chief Judge is appointed. The Chief Judge and the Deputy Chief Judge must be qualified as a FEIF International Sport judge.

Those with the right to nominate the Chief Judge and the Deputy Chief Judge are: the Member Countries, the Sport Judges Committee, the Sport Committee and the FEIF Board. Nominations shall be sent in and published in due time before the election.

The Chief Judge and the Deputy Chief Judges cannot be World Championship judges at the same time.

The responsibilities of the Chief Judge are as follows:

- to uphold the interests of the Judges at the competition;
- to head the Judges' meetings and briefing before, during and after the competition;
- supervise the shoeing control and the control of tack (ring stewards);
- to submit a written report on the competition to the FEIF board.

The Chief Judge sets the responsibilities of the Deputy Chief Judge.

S7.4.2 Appointment of judges

In addition to the chief judge and the deputy chief judge a group of 10 judges will be appointed to judge the World Championships. All judges must have been FEIF licensed international sport judges for a period of at least one year prior to their appointment. They also must have judged at least five FEIF WorldRanking events in the period of one year prior to their appointment.

The judges will be selected by a special selection committee of three; consisting of the World Championships Chief judge, one representative of the FEIF sport judges committee and one representative of the FEIF sport committee. The judges will be selected from a list of all entitled FEIF licensed international sport judges who have declared themselves available to the selection committee. A member of the selection committee can't be a judge at that same event.



The appointment of the judges' team should take place at least eight months prior to the World Championships. The judges must take part in the FEIF Judges' Seminar before the World Championships. The judges shall also attend the official judges' meetings during the World Championships.

The selection committee may select replacement judges as needed if a member of the World Championships jury must resign his position. The replacements are expected to attend all future judges' meetings but are excused from any meetings held before their selection.

S7.4.3 Judges and conflicts of interest

A judge must avoid any actual or perceived conflict of interest. A judge must have a neutral, independent and fair position towards riders, owners, trainers, organizers and other officials and integrate well into a team. Financial and/or personal interest must never influence or be perceived to influence his/her way of judging.

S7.4.4 Ring Stewards

During the tests there will be Ring Stewards (preferably judges) checking the riding equipment directly after the end of the test.

S7.4.5 Judges' Seminar and Conference

An official World Championship Judges' Seminar shall be organised under the responsibility of the FEIF Director of Sport. The meeting shall appoint the judges responsible for the shoeing check and set the time and agenda for the first judges' meeting at World Championships.

S7.4.6 Judges' meeting

Connected to the World Championships, but previous to the competitions, there shall be an official judges' meeting under the responsibility of the Chief Judge. As a minimum, the meeting shall deal with the following matters:

- set the system of sharing the tests among the judges at the World Championships;
- election of the judges responsible for timekeeping and starting;
- election of the head judge for each test.

S7.4.7 Judges' Meetings during World Championships

The Chief Judge is responsible for meetings and briefings during the World Championships.

S7.4.8 Judges' dress/equipment

Advertising on judges' clothes is not allowed

S7.5 Time Keeping

The use of electronic time-keeping equipment is mandatory for pace track tests, including video equipment in pace race, able to distinguish between riders; the FEIF Director of Sport shall approve the equipment.

S7.6 Starting order

The starting order will be drawn by lot. In preliminary rounds the starting order is drawn independent of the age class of the rider. The starting order drawn up must be strictly adhered to; any change even with the consent of those concerned is forbidden.



S7.7 Punctuality

In oval track tests and dressage tests, the rider shall be present with the horse in the collecting ring at least three minutes before the planned start of the test for that rider. In pace track tests, all riders involved shall be present with their horse in the collecting ring at least three minutes before the planned start of the test.

Otherwise the current FEIF General and Sport Rules apply.

S7.8 Demonstration rider

At World Championships a demonstration rider should ride the test 15 minutes before the start of each class. This performance is to be discussed by the judges in order to ensure uniform scoring. Teams must be notified if there will be no demonstration rider for a specific test.

S7.9 Team competition

At World Championships the winner of the Team Competition is the team that gets the highest sum of marks in the preliminary rounds (when applicable) in each test for the two highest ranked riders in that test. In case less than two riders participate in a test, the team will receive 0.00 per lacking rider.

S7.10 Arbitration Committee

For the duration of the World Championships an Arbitration Committee shall be established which shall consist of the following:

- the head of the organising committee or one representative previously appointed by him;
- a member of the organisation committee;
- the head judge or one member of the judging staff previously appointed by him
- the sport representative of FEIF or a previously appointed member of the FEIF-sport committee;
- a rider's spokesman elected before the start of the tournament by the Team spokesmen (one per team). If the rider's spokesman has to be substituted the rider with the second highest votes will become the spokesman's representative.

The previously appointed representatives can only represent in such cases where the member he substitutes is involved in the situation or has an interest therein.

S7.11 Tests

The World Championship tests are as follows: T1, T2, V1, F1, P1, PP1, and P2. The tests will be carried out according to the current FEIF Sport Rules and are judged according to the current Sport Judges' Guidelines.

5 Judges judge all oval track tests. The Pace Race (P1) will be conducted in 4 runs.

Adult age class: there shall be A- and B-finals in oval track unless decided otherwise.

Young Riders class: there shall be A-finals in oval track test. For B-finals a minimum of 21 Young Riders in the preliminaries are required, unless decided otherwise.



S8 Appendix 1: WorldRanking

1. Under the supervision of the FEIF Director of Sport a WorldRanking is maintained for riders that participate in the tests: Tölt T1, T2, T3, and T4; Five Gait F1 and F2; Four Gait V1 and V2, Pace test PP1, Pace race 250m P1 and 150 m P3, SpeedPass P2.
2. The FEIF Director of Sport can delegate the duties connected to the WorldRanking to a sub-committee.
3. It is not permissible to have more than one World Ranking tournament at the same location on the same dates.
4. A list with all competitions announced is published in April.
5. Five qualified judges shall judge all oval track tests. Three of the required judges for all tests (pace and oval track) must be FEIF International Sport Judges, at least one of these 3 has to have his/her country of residence abroad.
6. The time that judges are judging has to be limited to reasonable hours, to ensure proper judging. This means a maximum of 10 consecutive hours per day, including a 30 minutes lunch break and short breaks of 10 minutes each 2 hours of judging.
7. The required length of the oval track for WorldRanking tests is 250m.
8. Equipment checks on all horses in finals and at least 25% of the horses in preliminary rounds are mandatory.
9. Announcements have to be made in English or at least a language all judges (and preferably riders and public) can understand.
10. For all riders, results of 5.5 or higher in the preliminary rounds; 26.60 seconds or faster in P1; 16.50 seconds or faster in P3; and, 8.70 seconds or faster in P2 are entered in the WorldRanking. For PP1 only results including two runs are valid.
11. Results should be sent in to the WorldRanking Office immediately after each event by the national WorldRanking registrar. If the results are not received until 21 days after the event, the event will no longer be listed as WorldRanking event and the system will not accept the results. For re-listing of the event the financial contributions for late entry apply.
12. The FEIF member organisation is responsible for correct results. A copy of the data entered is sent back to the national registrar to check.
13. By sending in results you confirm that all tests have been performed and judged according to the FEIF General and Sport Rules including the additional WorldRanking rules.
14. Any score entered is valid for a period of two years from the last day of the competition involved (until but not including the same date two years later).
15. The ranking per test named above is based on the arrhythmic mean of the three best scores per rider. Any result better or equal will replace a previous score.
16. Since the ranking is based on a continuous system (results will count for two years), there is no final ranking.
17. From the moment a rider has three valid scores in one test, his or her name is published in the Ranking List.



18. To cover the costs, FEIF member organisations pay a fee per competition announced for the list. The fee is set by the FEIF Director of Sport. The national FEIF member associations will receive a bill for the amount due. Until March 1, entries may be changed without any extra costs. Events added after March 1 will be charged an extra fee. Events cancelled after March 1 will still be assessed the fee.
19. There will be an additional charge of 100% per competition above the standard fee for any event registered after March 1 or any event re-registered after late results are received.
20. The FEIF Sport Committee may fine organizers up to an amount of 5.000€ if organizers do not follow the WorldRanking rules or engage in discriminatory behaviour toward the riders.
21. In any case not foreseen, the FEIF Sport committee will decide.



S9 Appendix 2: International Sport Judge Examination

FEIF organises, at least once every two years, a test for national sport judges to become international sport judges. In addition, FEIF provides a service for member associations to test judges to become national sport judges.

S9.1.1 Purpose

The examination for international sport judge provides an equal standard among the international sport judges. For national judges FEIF provides a chance for those countries, which cannot organise such an examination, to have their judges tested.

Candidates who pass the test as international judges receive a license as FEIF International Sport Judge for the period of three years. The license can be renewed in two ways:

- pass the examination again, or
- take part in at least one International Sport Judges' seminar organised by FEIF and be a full judge for at least 15 days of WorldRanking events in this three years' period.¹¹
- participate in all formal, online video judging exercises

Candidates who pass the test for a national judge license receive a recommendation to receive a license from their member association. The final decision to issue the license rests with the member association.

S9.1.2 Candidate Requirements

International FEIF License Candidates:

Candidates for the examination are enrolled in the examination by their member associations. Each member association is expected to only send those candidates with sufficient training and experience to be prepared for this high-level challenge. At a minimum, candidates must have held a national license for at least two years.

Candidates for the international test must be at least 21 years old and be a member of a member association of FEIF.

Candidates must also have a proven riding capacity (license, trainer exam, national judge exam if this contains riding, competition results, etc.)

The FEIF Sport Judges Committee may limit the number of candidates allowed to attempt the international license. If a limit is imposed, the Sport Judges Committee will select candidates based on their performance during an online video judging exercise. Candidates will be accepted to attempt the examination based on the number of available places and their ranking in the video judging exercise.

Each sponsoring country is responsible for ensuring their candidates judge the online videos individually. It is in the candidate's best interest to judge these videos honestly. This pre-test is in place to spare candidates the time, expense, and stress of attempting an exam they are will likely fail.

National Examination Candidates:

For candidates for the national test it is up to the member association to decide who may take part in the test.

¹¹ The International Sport Judge license renewal demands are subject to change by the Board of FEIF.



S9.1.3 Board of Examiners

The Board of Examiners consists of five FEIF International Sport Judges who also have experience in this kind of examination. The Director of Sport appoints the board based on recommendations from the FEIF Sport Judges Committee.

An observer of FEIF to be appointed by the Director of Sport must be present during all three portions of the examination. The observer may comment during deliberations but is not entitled to vote on any final decision.

All decisions regarding the examination and final pass/fail recommendations are made by majority vote of the examiners.

The Board of Examiners has the following tasks:

- preparation of the bank of written test questions;
- evaluation of the answers to the written test questions;
- selection of videos to be used during the oral portion of the exam;
- questioning for the oral portion of the exam;
- examination of the oral part;
- deciding upon the results of the practical portion (See S8.1.5)
- recommendation of the candidates for appointment as FEIF Licensed Sport Judge by the Director of Sport or recommendation for appointment as a national judge.

S9.1.4 Content of the Examination

The examination is designed to test the candidates' knowledge of theoretical concepts of equitation, understanding the FEIF Rules and Regulations, and application of the Sport Judges' Guidelines to ridden and video presentations.

The following topics are part of the examination:

- Training methods, riding
- Relevant sections of the FEIF Rules and Regulations including the entire content of the Sport Rules and those sections of the General Rules which a sport judge might reasonably expect to apply during the normal work at a World Ranking tournament.
- Sport Judges' Guidelines
- Comment on a video presentation
- Judgement of live horse presentations

The examination is divided into three parts all of which must be passed for the candidate to receive a license or recommendation for a license¹²:

1. Written – The written portion tests the candidates' knowledge of equitation theory, rules, and guidelines. The examination is presented in English. Candidates for a national recommendation may ask for translation assistance. Candidates for an international license must be sufficiently competent in English to answer the written questions.

¹² FEIF member associations may request their candidates only take the practical part of the examination. This is up to each association and should be declared to the candidate and FEIF when a candidate is registered to take the examination for a national license recommendation.



2. Oral – This portion of the test includes judging and commenting on a video performance. The candidate is expected to describe performance in the terms found in the Sport Judges' Guidelines. The candidate is expected to give a mark for each section of the performance and justify the mark using the terminology from the Sport Judges' Guidelines.

The examiners may ask additional questions to explore the candidate's understanding of how the horse is moving; how the rider is effecting the performance in a positive or negative way; and, what the rider might do differently for a better outcome.

This part of the examination is conducted in English. Candidates for the International license must be able to function in English well enough to discuss judging matters with their colleagues. For purposed of the examination, the panel of examiners acts as the judging colleagues.

Candidates are not required to be fluent in English but must be able to make themselves understood in English during the oral portion of the examination. A candidate who is unable to do so cannot pass the oral portion of the examination because the examiners cannot conclude the judge will be able to discuss judging matters with colleagues on a tournament.

Candidates for a national license recommendation may use their own language. In such case the Board of Examiners may require an interpreter if the panel does not have sufficient experience in the candidate's language.

3. Practical – The candidates judge presentation of live horses in the following tests: T1, T2, V1, F1, PP1. (See S8.1.5)

S9.1.5 Execution of the Practical Portion

Candidates should judge 8 - 15 horses per test in T1, T2, V1, F1, and PP1. A minimum of 5 horses in each test is required. If this minimum is not met the examination must be cancelled. The examiners have the right to exclude the results from a specific horse in a specific test if they feel including the horse would be unfair to the candidates for a specific reason.

Candidates give marks accompanied by comments for each section of the Sport tests. There is no need for the candidates to calculate a final mark other than to decide on a final mark for the pace portion of F1.

Each of the examiners individually gives marks and comments at the same time as the candidates.

Immediately following each horse, the examiners must come together away from the candidates to agree on the range of acceptable marks for each section of the performance. The examiners must also determine the penalty points for a reasonable set of marks outside the accepted range.

The penalty points characterize the degree of misjudgement shown by a candidate by giving a mark outside the acceptable range. This penalty point system acknowledges the fact that subjective examinations cannot be based exclusively on mathematical considerations. The examiners must evaluate the circumstances for each horse when fixing the acceptable range and penalty points. For example: when the examiners consider a horse that is extremely difficult to judge, they can decide to treat the deviations from the acceptable range in a more generous way.

Penalties are assigned as follows:



- Within the accepted range = 0 points
- Slight deviation = 1 point
- Medium deviation = 3 points
- Strong deviation = 5 points
- Extreme fault = 10 points

This process is repeated for all horses in the required oval track tests.

The process for examining PP1 is slightly different. The candidates and examiners all judge the horses together in two sections. Each horse will make two sprints. During the first sprint the candidates and examiners give marks for the laying into pace and the quality of the first half of the pace sprint. During the second sprint the candidates and examiners give marks for the second half of the pace quality and the slowing to walk.

The system for agreement on accepted marks and penalty points is the same as for the oval track tests.

This unusual handling of PP1 gives a fair assessment of the candidates' abilities to judge the test without asking each horse to make four sprints.

S9.1.6 Calculation of the Results of the Practical Portion

Candidates must pass each individual test and the aggregation of all the tests to pass the practical portion of the examination.

The results for each test are calculated using the following formula:

$$Result(test) = \frac{\sum \text{penalty points}}{(\#sections) \times (\#horses \div 10)}$$

The overall results for the examination are calculated using the following formula:

$$Result(overall) = \frac{\sum \text{all penalty points}}{\sum_{tests} [(\#sections) \times (\#horses \div 10)]}$$

In both cases the calculated result must be less than 4.0 for international candidates and less than 6.0 for national candidates.

S9.1.7 Re-Examination

International license candidates must pass all parts of the exam to be recommended as a FEIF Licensed International Sport Judge. It is possible to arrange a re-examination if the candidate does not pass the oral or written parts of the exam but does pass the practical part. Such a re-examination will be arranged by the Director of Sport at additional cost to the candidate and at a time and place convenient for both FEIF and the candidate(s).

The re-examination must take place within one year of the original license examination.

S9.1.8 Objections

Candidates have the right to object based on the execution of the examination.

Candidates do not have the right to object to the marks or the penalty points assigned by the Board of Examiners as described in S8.1.5. Candidates may protest the interpretation of their marks only if those marks include supporting comments. Marks given without comment cannot be appealed.

Protests must be submitted in writing to the Board of FEIF within one week of the publication of the results of the examination.



S10 Appendix 3: Time table P1 Pace Race 250 m

The marks for any time in seconds (two decimals) are calculated with the following formula:

$$(32.50 - t) / 1.25$$

where t = the time of the fastest run in the appropriate number of decimals

Marks cannot be higher than 10.00 or lower than 0.00.

Time	Mark	20.31	9.75	20.63	9.50	20.95	9.24	21.27	8.98	21.59	8.73
20.00	10.00	20.32	9.74	20.64	9.49	20.96	9.23	21.28	8.98	21.60	8.72
20.01	9.99	20.33	9.74	20.65	9.48	20.97	9.22	21.29	8.97	21.61	8.71
20.02	9.98	20.34	9.73	20.66	9.47	20.98	9.22	21.30	8.96	21.62	8.70
20.03	9.98	20.35	9.72	20.67	9.46	20.99	9.21	21.31	8.95	21.63	8.70
20.04	9.97	20.36	9.71	20.68	9.46	21.00	9.20	21.32	8.94	21.64	8.69
20.05	9.96	20.37	9.70	20.69	9.45	21.01	9.19	21.33	8.94	21.65	8.68
20.06	9.95	20.38	9.70	20.70	9.44	21.02	9.18	21.34	8.93	21.66	8.67
20.07	9.94	20.39	9.69	20.71	9.43	21.03	9.18	21.35	8.92	21.67	8.66
20.08	9.94	20.40	9.68	20.72	9.42	21.04	9.17	21.36	8.91	21.68	8.66
20.09	9.93	20.41	9.67	20.73	9.42	21.05	9.16	21.37	8.90	21.69	8.65
20.10	9.92	20.42	9.66	20.74	9.41	21.06	9.15	21.38	8.90	21.70	8.64
20.11	9.91	20.43	9.66	20.75	9.40	21.07	9.14	21.39	8.89	21.71	8.63
20.12	9.90	20.44	9.65	20.76	9.39	21.08	9.14	21.40	8.88	21.72	8.62
20.13	9.90	20.45	9.64	20.77	9.38	21.09	9.13	21.41	8.87	21.73	8.62
20.14	9.89	20.46	9.63	20.78	9.38	21.10	9.12	21.42	8.86	21.74	8.61
20.15	9.88	20.47	9.62	20.79	9.37	21.11	9.11	21.43	8.86	21.75	8.60
20.16	9.87	20.48	9.62	20.80	9.36	21.12	9.10	21.44	8.85	21.76	8.59
20.17	9.86	20.49	9.61	20.81	9.35	21.13	9.10	21.45	8.84	21.77	8.58
20.18	9.86	20.50	9.60	20.82	9.34	21.14	9.09	21.46	8.83	21.78	8.58
20.19	9.85	20.51	9.59	20.83	9.34	21.15	9.08	21.47	8.82	21.79	8.57
20.20	9.84	20.52	9.58	20.84	9.33	21.16	9.07	21.48	8.82	21.80	8.56
20.21	9.83	20.53	9.58	20.85	9.32	21.17	9.06	21.49	8.81	21.81	8.55
20.22	9.82	20.54	9.57	20.86	9.31	21.18	9.06	21.50	8.80	21.82	8.54
20.23	9.82	20.55	9.56	20.87	9.30	21.19	9.05	21.51	8.79	21.83	8.54
20.24	9.81	20.56	9.55	20.88	9.30	21.20	9.04	21.52	8.78	21.84	8.53
20.25	9.80	20.57	9.54	20.89	9.29	21.21	9.03	21.53	8.78	21.85	8.52
20.26	9.79	20.58	9.54	20.90	9.28	21.22	9.02	21.54	8.77	21.86	8.51
20.27	9.78	20.59	9.53	20.91	9.27	21.23	9.02	21.55	8.76	21.87	8.50
20.28	9.78	20.60	9.52	20.92	9.26	21.24	9.01	21.56	8.75	21.88	8.50
20.29	9.77	20.61	9.51	20.93	9.26	21.25	9.00	21.57	8.74	21.89	8.49
20.30	9.76	20.62	9.50	20.94	9.25	21.26	8.99	21.58	8.74	21.90	8.48



21.91	8.47	22.31	8.15	22.71	7.83	23.11	7.51	23.51	7.19	23.91	6.87
21.92	8.46	22.32	8.14	22.72	7.82	23.12	7.50	23.52	7.18	23.92	6.86
21.93	8.46	22.33	8.14	22.73	7.82	23.13	7.50	23.53	7.18	23.93	6.86
21.94	8.45	22.34	8.13	22.74	7.81	23.14	7.49	23.54	7.17	23.94	6.85
21.95	8.44	22.35	8.12	22.75	7.80	23.15	7.48	23.55	7.16	23.95	6.84
21.96	8.43	22.36	8.11	22.76	7.79	23.16	7.47	23.56	7.15	23.96	6.83
21.97	8.42	22.37	8.10	22.77	7.78	23.17	7.46	23.57	7.14	23.97	6.82
21.98	8.42	22.38	8.10	22.78	7.78	23.18	7.46	23.58	7.14	23.98	6.82
21.99	8.41	22.39	8.09	22.79	7.77	23.19	7.45	23.59	7.13	23.99	6.81
22.00	8.40	22.40	8.08	22.80	7.76	23.20	7.44	23.60	7.12	24.00	6.80
22.01	8.39	22.41	8.07	22.81	7.75	23.21	7.43	23.61	7.11	24.01	6.79
22.02	8.38	22.42	8.06	22.82	7.74	23.22	7.42	23.62	7.10	24.02	6.78
22.03	8.38	22.43	8.06	22.83	7.74	23.23	7.42	23.63	7.10	24.03	6.78
22.04	8.37	22.44	8.05	22.84	7.73	23.24	7.41	23.64	7.09	24.04	6.77
22.05	8.36	22.45	8.04	22.85	7.72	23.25	7.40	23.65	7.08	24.05	6.76
22.06	8.35	22.46	8.03	22.86	7.71	23.26	7.39	23.66	7.07	24.06	6.75
22.07	8.34	22.47	8.02	22.87	7.70	23.27	7.38	23.67	7.06	24.07	6.74
22.08	8.34	22.48	8.02	22.88	7.70	23.28	7.38	23.68	7.06	24.08	6.74
22.09	8.33	22.49	8.01	22.89	7.69	23.29	7.37	23.69	7.05	24.09	6.73
22.10	8.32	22.50	8.00	22.90	7.68	23.30	7.36	23.70	7.04	24.10	6.72
22.11	8.31	22.51	7.99	22.91	7.67	23.31	7.35	23.71	7.03	24.11	6.71
22.12	8.30	22.52	7.98	22.92	7.66	23.32	7.34	23.72	7.02	24.12	6.70
22.13	8.30	22.53	7.98	22.93	7.66	23.33	7.34	23.73	7.02	24.13	6.70
22.14	8.29	22.54	7.97	22.94	7.65	23.34	7.33	23.74	7.01	24.14	6.69
22.15	8.28	22.55	7.96	22.95	7.64	23.35	7.32	23.75	7.00	24.15	6.68
22.16	8.27	22.56	7.95	22.96	7.63	23.36	7.31	23.76	6.99	24.16	6.67
22.17	8.26	22.57	7.94	22.97	7.62	23.37	7.30	23.77	6.98	24.17	6.66
22.18	8.26	22.58	7.94	22.98	7.62	23.38	7.30	23.78	6.98	24.18	6.66
22.19	8.25	22.59	7.93	22.99	7.61	23.39	7.29	23.79	6.97	24.19	6.65
22.20	8.24	22.60	7.92	23.00	7.60	23.40	7.28	23.80	6.96	24.20	6.64
22.21	8.23	22.61	7.91	23.01	7.59	23.41	7.27	23.81	6.95	24.21	6.63
22.22	8.22	22.62	7.90	23.02	7.58	23.42	7.26	23.82	6.94	24.22	6.62
22.23	8.22	22.63	7.90	23.03	7.58	23.43	7.26	23.83	6.94	24.23	6.62
22.24	8.21	22.64	7.89	23.04	7.57	23.44	7.25	23.84	6.93	24.24	6.61
22.25	8.20	22.65	7.88	23.05	7.56	23.45	7.24	23.85	6.92	24.25	6.60
22.26	8.19	22.66	7.87	23.06	7.55	23.46	7.23	23.86	6.91	24.26	6.59
22.27	8.18	22.67	7.86	23.07	7.54	23.47	7.22	23.87	6.90	24.27	6.58
22.28	8.18	22.68	7.86	23.08	7.54	23.48	7.22	23.88	6.90	24.28	6.58
22.29	8.17	22.69	7.85	23.09	7.53	23.49	7.21	23.89	6.89	24.29	6.57
22.30	8.16	22.70	7.84	23.10	7.52	23.50	7.20	23.90	6.88		



24.30	6.56	24.70	6.24	25.10	5.92	25.50	5.60	25.90	5.28	26.30	4.96
24.31	6.55	24.71	6.23	25.11	5.91	25.51	5.59	25.91	5.27	26.31	4.95
24.32	6.54	24.72	6.22	25.12	5.90	25.52	5.58	25.92	5.26	26.32	4.94
24.33	6.54	24.73	6.22	25.13	5.90	25.53	5.58	25.93	5.26	26.33	4.94
24.34	6.53	24.74	6.21	25.14	5.89	25.54	5.57	25.94	5.25	26.34	4.93
24.35	6.52	24.75	6.20	25.15	5.88	25.55	5.56	25.95	5.24	26.35	4.92
24.36	6.51	24.76	6.19	25.16	5.87	25.56	5.55	25.96	5.23	26.36	4.91
24.37	6.50	24.77	6.18	25.17	5.86	25.57	5.54	25.97	5.22	26.37	4.90
24.38	6.50	24.78	6.18	25.18	5.86	25.58	5.54	25.98	5.22	26.38	4.90
24.39	6.49	24.79	6.17	25.19	5.85	25.59	5.53	25.99	5.21	26.39	4.89
24.40	6.48	24.80	6.16	25.20	5.84	25.60	5.52	26.00	5.20	26.40	4.88
24.41	6.47	24.81	6.15	25.21	5.83	25.61	5.51	26.01	5.19	26.41	4.87
24.42	6.46	24.82	6.14	25.22	5.82	25.62	5.50	26.02	5.18	26.42	4.86
24.43	6.46	24.83	6.14	25.23	5.82	25.63	5.50	26.03	5.18	26.43	4.86
24.44	6.45	24.84	6.13	25.24	5.81	25.64	5.49	26.04	5.17	26.44	4.85
24.45	6.44	24.85	6.12	25.25	5.80	25.65	5.48	26.05	5.16	26.45	4.84
24.46	6.43	24.86	6.11	25.26	5.79	25.66	5.47	26.06	5.15	26.46	4.83
24.47	6.42	24.87	6.10	25.27	5.78	25.67	5.46	26.07	5.14	26.47	4.82
24.48	6.42	24.88	6.10	25.28	5.78	25.68	5.46	26.08	5.14	26.48	4.82
24.49	6.41	24.89	6.09	25.29	5.77	25.69	5.45	26.09	5.13	26.49	4.81
24.50	6.40	24.90	6.08	25.30	5.76	25.70	5.44	26.10	5.12	26.50	4.80
24.51	6.39	24.91	6.07	25.31	5.75	25.71	5.43	26.11	5.11	26.51	4.79
24.52	6.38	24.92	6.06	25.32	5.74	25.72	5.42	26.12	5.10	26.52	4.78
24.53	6.38	24.93	6.06	25.33	5.74	25.73	5.42	26.13	5.10	26.53	4.78
24.54	6.37	24.94	6.05	25.34	5.73	25.74	5.41	26.14	5.09	26.54	4.77
24.55	6.36	24.95	6.04	25.35	5.72	25.75	5.40	26.15	5.08	26.55	4.76
24.56	6.35	24.96	6.03	25.36	5.71	25.76	5.39	26.16	5.07	26.56	4.75
24.57	6.34	24.97	6.02	25.37	5.70	25.77	5.38	26.17	5.06	26.57	4.74
24.58	6.34	24.98	6.02	25.38	5.70	25.78	5.38	26.18	5.06	26.58	4.74
24.59	6.33	24.99	6.01	25.39	5.69	25.79	5.37	26.19	5.05	26.59	4.73
24.60	6.32	25.00	6.00	25.40	5.68	25.80	5.36	26.20	5.04	26.60	4.72
24.61	6.31	25.01	5.99	25.41	5.67	25.81	5.35	26.21	5.03	26.61	4.71
24.62	6.30	25.02	5.98	25.42	5.66	25.82	5.34	26.22	5.02	26.62	4.70
24.63	6.30	25.03	5.98	25.43	5.66	25.83	5.34	26.23	5.02	26.63	4.70
24.64	6.29	25.04	5.97	25.44	5.65	25.84	5.33	26.24	5.01	26.64	4.69
24.65	6.28	25.05	5.96	25.45	5.64	25.85	5.32	26.25	5.00	26.65	4.68
24.66	6.27	25.06	5.95	25.46	5.63	25.86	5.31	26.26	4.99	26.66	4.67
24.67	6.26	25.07	5.94	25.47	5.62	25.87	5.30	26.27	4.98	26.67	4.66
24.68	6.26	25.08	5.94	25.48	5.62	25.88	5.30	26.28	4.98	26.68	4.66
24.69	6.25	25.09	5.93	25.49	5.61	25.89	5.29	26.29	4.97	26.69	4.65



26.70	4.64	27.10	4.32	27.50	4.00	27.90	3.68	28.30	3.36	28.70	3.04
26.71	4.63	27.11	4.31	27.51	3.99	27.91	3.67	28.31	3.35	28.71	3.03
26.72	4.62	27.12	4.30	27.52	3.98	27.92	3.66	28.32	3.34	28.72	3.02
26.73	4.62	27.13	4.30	27.53	3.98	27.93	3.66	28.33	3.34	28.73	3.02
26.74	4.61	27.14	4.29	27.54	3.97	27.94	3.65	28.34	3.33	28.74	3.01
26.75	4.60	27.15	4.28	27.55	3.96	27.95	3.64	28.35	3.32	28.75	3.00
26.76	4.59	27.16	4.27	27.56	3.95	27.96	3.63	28.36	3.31	28.76	2.99
26.77	4.58	27.17	4.26	27.57	3.94	27.97	3.62	28.37	3.30	28.77	2.98
26.78	4.58	27.18	4.26	27.58	3.94	27.98	3.62	28.38	3.30	28.78	2.98
26.79	4.57	27.19	4.25	27.59	3.93	27.99	3.61	28.39	3.29	28.79	2.97
26.80	4.56	27.20	4.24	27.60	3.92	28.00	3.60	28.40	3.28	28.80	2.96
26.81	4.55	27.21	4.23	27.61	3.91	28.01	3.59	28.41	3.27	28.81	2.95
26.82	4.54	27.22	4.22	27.62	3.90	28.02	3.58	28.42	3.26	28.82	2.94
26.83	4.54	27.23	4.22	27.63	3.90	28.03	3.58	28.43	3.26	28.83	2.94
26.84	4.53	27.24	4.21	27.64	3.89	28.04	3.57	28.44	3.25	28.84	2.93
26.85	4.52	27.25	4.20	27.65	3.88	28.05	3.56	28.45	3.24	28.85	2.92
26.86	4.51	27.26	4.19	27.66	3.87	28.06	3.55	28.46	3.23	28.86	2.91
26.87	4.50	27.27	4.18	27.67	3.86	28.07	3.54	28.47	3.22	28.87	2.90
26.88	4.50	27.28	4.18	27.68	3.86	28.08	3.54	28.48	3.22	28.88	2.90
26.89	4.49	27.29	4.17	27.69	3.85	28.09	3.53	28.49	3.21	28.89	2.89
26.90	4.48	27.30	4.16	27.70	3.84	28.10	3.52	28.50	3.20	28.90	2.88
26.91	4.47	27.31	4.15	27.71	3.83	28.11	3.51	28.51	3.19	28.91	2.87
26.92	4.46	27.32	4.14	27.72	3.82	28.12	3.50	28.52	3.18	28.92	2.86
26.93	4.46	27.33	4.14	27.73	3.82	28.13	3.50	28.53	3.18	28.93	2.86
26.94	4.45	27.34	4.13	27.74	3.81	28.14	3.49	28.54	3.17	28.94	2.85
26.95	4.44	27.35	4.12	27.75	3.80	28.15	3.48	28.55	3.16	28.95	2.84
26.96	4.43	27.36	4.11	27.76	3.79	28.16	3.47	28.56	3.15	28.96	2.83
26.97	4.42	27.37	4.10	27.77	3.78	28.17	3.46	28.57	3.14	28.97	2.82
26.98	4.42	27.38	4.10	27.78	3.78	28.18	3.46	28.58	3.14	28.98	2.82
26.99	4.41	27.39	4.09	27.79	3.77	28.19	3.45	28.59	3.13	28.99	2.81
27.00	4.40	27.40	4.08	27.80	3.76	28.20	3.44	28.60	3.12	29.00	2.80
27.01	4.39	27.41	4.07	27.81	3.75	28.21	3.43	28.61	3.11	29.01	2.79
27.02	4.38	27.42	4.06	27.82	3.74	28.22	3.42	28.62	3.10	29.02	2.78
27.03	4.38	27.43	4.06	27.83	3.74	28.23	3.42	28.63	3.10	29.03	2.78
27.04	4.37	27.44	4.05	27.84	3.73	28.24	3.41	28.64	3.09	29.04	2.77
27.05	4.36	27.45	4.04	27.85	3.72	28.25	3.40	28.65	3.08	29.05	2.76
27.06	4.35	27.46	4.03	27.86	3.71	28.26	3.39	28.66	3.07	29.06	2.75
27.07	4.34	27.47	4.02	27.87	3.70	28.27	3.38	28.67	3.06	29.07	2.74
27.08	4.34	27.48	4.02	27.88	3.70	28.28	3.38	28.68	3.06	29.08	2.74
27.09	4.33	27.49	4.01	27.89	3.69	28.29	3.37	28.69	3.05	29.09	2.73



29.10	2.72	29.50	2.40	29.90	2.08	30.30	1.76	30.69	1.45	31.09	1.13
29.11	2.71	29.51	2.39	29.91	2.07	30.31	1.75	30.70	1.44	31.10	1.12
29.12	2.70	29.52	2.38	29.92	2.06	30.32	1.74	30.71	1.43	31.11	1.11
29.13	2.70	29.53	2.38	29.93	2.06	30.33	1.74	30.72	1.42	31.12	1.10
29.14	2.69	29.54	2.37	29.94	2.05	30.34	1.73	30.73	1.42	31.13	1.10
29.15	2.68	29.55	2.36	29.95	2.04	30.35	1.72	30.74	1.41	31.14	1.09
29.16	2.67	29.56	2.35	29.96	2.03	30.36	1.71	30.75	1.40	31.15	1.08
29.17	2.66	29.57	2.34	29.97	2.02	30.37	1.70	30.76	1.39	31.16	1.07
29.18	2.66	29.58	2.34	29.98	2.02	30.38	1.70	30.77	1.38	31.17	1.06
29.19	2.65	29.59	2.33	29.99	2.01	30.39	1.69	30.78	1.38	31.18	1.06
29.20	2.64	29.60	2.32	30.00	2.00	30.40	1.68	30.79	1.37	31.19	1.05
29.21	2.63	29.61	2.31	30.01	1.99	30.41	1.67	30.80	1.36	31.20	1.04
29.22	2.62	29.62	2.30	30.02	1.98	30.42	1.66	30.81	1.35	31.21	1.03
29.23	2.62	29.63	2.30	30.03	1.98	30.43	1.66	30.82	1.34	31.22	1.02
29.24	2.61	29.64	2.29	30.04	1.97	30.44	1.65	30.83	1.34	31.23	1.02
29.25	2.60	29.65	2.28	30.05	1.96	30.45	1.64	30.84	1.33	31.24	1.01
29.26	2.59	29.66	2.27	30.06	1.95	30.46	1.63	30.85	1.32	31.25	1.00
29.27	2.58	29.67	2.26	30.07	1.94	30.47	1.62	30.86	1.31	31.26	0.99
29.28	2.58	29.68	2.26	30.08	1.94	30.48	1.62	30.87	1.30	31.27	0.98
29.29	2.57	29.69	2.25	30.09	1.93	30.49	1.61	30.88	1.30	31.28	0.98
29.30	2.56	29.70	2.24	30.10	1.92	30.50	1.60	30.89	1.29	31.29	0.97
29.31	2.55	29.71	2.23	30.11	1.91	30.51	1.59	30.90	1.28	31.30	0.96
29.32	2.54	29.72	2.22	30.12	1.90	30.52	1.58	30.91	1.27	31.31	0.95
29.33	2.54	29.73	2.22	30.13	1.90	30.53	1.58	30.92	1.26	31.32	0.94
29.34	2.53	29.74	2.21	30.14	1.89	30.54	1.57	30.93	1.26	31.33	0.94
29.35	2.52	29.75	2.20	30.15	1.88	30.55	1.56	30.94	1.25	31.34	0.93
29.36	2.51	29.76	2.19	30.16	1.87	30.56	1.55	30.95	1.24	31.35	0.92
29.37	2.50	29.77	2.18	30.17	1.86	30.57	1.54	30.96	1.23	31.36	0.91
29.38	2.50	29.78	2.18	30.18	1.86	30.58	1.54	30.97	1.22	31.37	0.90
29.39	2.49	29.79	2.17	30.19	1.85	30.59	1.53	30.98	1.22	31.38	0.90
29.40	2.48	29.80	2.16	30.20	1.84	30.60	1.52	30.99	1.21	31.39	0.89
29.41	2.47	29.81	2.15	30.21	1.83	30.61	1.51	31.00	1.20	31.40	0.88
29.42	2.46	29.82	2.14	30.22	1.82	30.62	1.50	31.01	1.19	31.41	0.87
29.43	2.46	29.83	2.14	30.23	1.82	30.63	1.50	31.02	1.18	31.42	0.86
29.44	2.45	29.84	2.13	30.24	1.81	30.64	1.49	31.03	1.18	31.43	0.86
29.45	2.44	29.85	2.12	30.25	1.80	30.65	1.48	31.04	1.17	31.44	0.85
29.46	2.43	29.86	2.11	30.26	1.79	30.66	1.47	31.05	1.16	31.45	0.84
29.47	2.42	29.87	2.10	30.27	1.78	30.67	1.46	31.06	1.15	31.46	0.83
29.48	2.42	29.88	2.10	30.28	1.78	30.68	1.46	31.07	1.14	31.47	0.82
29.49	2.41	29.89	2.09	30.29	1.77			31.08	1.14	31.48	0.82



31.49	0.81	31.66	0.67	31.83	0.54	32.00	0.40	32.17	0.26	32.34	0.13
31.50	0.80	31.67	0.66	31.84	0.53	32.01	0.39	32.18	0.26	32.35	0.12
31.51	0.79	31.68	0.66	31.85	0.52	32.02	0.38	32.19	0.25	32.36	0.11
31.52	0.78	31.69	0.65	31.86	0.51	32.03	0.38	32.20	0.24	32.37	0.10
31.53	0.78	31.70	0.64	31.87	0.50	32.04	0.37	32.21	0.23	32.38	0.10
31.54	0.77	31.71	0.63	31.88	0.50	32.05	0.36	32.22	0.22	32.39	0.09
31.55	0.76	31.72	0.62	31.89	0.49	32.06	0.35	32.23	0.22	32.40	0.08
31.56	0.75	31.73	0.62	31.90	0.48	32.07	0.34	32.24	0.21	32.41	0.07
31.57	0.74	31.74	0.61	31.91	0.47	32.08	0.34	32.25	0.20	32.42	0.06
31.58	0.74	31.75	0.60	31.92	0.46	32.09	0.33	32.26	0.19	32.43	0.06
31.59	0.73	31.76	0.59	31.93	0.46	32.10	0.32	32.27	0.18	32.44	0.05
31.60	0.72	31.77	0.58	31.94	0.45	32.11	0.31	32.28	0.18	32.45	0.04
31.61	0.71	31.78	0.58	31.95	0.44	32.12	0.30	32.29	0.17	32.46	0.03
31.62	0.70	31.79	0.57	31.96	0.43	32.13	0.30	32.30	0.16	32.47	0.02
31.63	0.70	31.80	0.56	31.97	0.42	32.14	0.29	32.31	0.15	32.48	0.02
31.64	0.69	31.81	0.55	31.98	0.42	32.15	0.28	32.32	0.14	32.49	0.01
31.65	0.68	31.82	0.54	31.99	0.41	32.16	0.27	32.33	0.14	32.50	0.00



S11 Appendix 4: Time table P2 SpeedPass 100 m

The marks for any time in seconds (two decimals) are calculated with the following formula:

$$(12.00 - t) / 0.60$$

where t = the time of the fastest run in the appropriate number of decimals

Marks cannot be higher than 10.00 or lower than 0.00.

Time	Mark	06.31	9.48	06.63	8.95	06.95	8.42	07.27	7.88	07.59	7.35
06.00	10.00	06.32	9.47	06.64	8.93	06.96	8.40	07.28	7.87	07.60	7.33
06.01	9.98	06.33	9.45	06.65	8.92	06.97	8.38	07.29	7.85	07.61	7.32
06.02	9.97	06.34	9.43	06.66	8.90	06.98	8.37	07.30	7.83	07.62	7.30
06.03	9.95	06.35	9.42	06.67	8.88	06.99	8.35	07.31	7.82	07.63	7.28
06.04	9.93	06.36	9.40	06.68	8.87	07.00	8.33	07.32	7.80	07.64	7.27
06.05	9.92	06.37	9.38	06.69	8.85	07.01	8.32	07.33	7.78	07.65	7.25
06.06	9.90	06.38	9.37	06.70	8.83	07.02	8.30	07.34	7.77	07.66	7.23
06.07	9.88	06.39	9.35	06.71	8.82	07.03	8.28	07.35	7.75	07.67	7.22
06.08	9.87	06.40	9.33	06.72	8.80	07.04	8.27	07.36	7.73	07.68	7.20
06.09	9.85	06.41	9.32	06.73	8.78	07.05	8.25	07.37	7.72	07.69	7.18
06.10	9.83	06.42	9.30	06.74	8.77	07.06	8.23	07.38	7.70	07.70	7.17
06.11	9.82	06.43	9.28	06.75	8.75	07.07	8.22	07.39	7.68	07.71	7.15
06.12	9.80	06.44	9.27	06.76	8.73	07.08	8.20	07.40	7.67	07.72	7.13
06.13	9.78	06.45	9.25	06.77	8.72	07.09	8.18	07.41	7.65	07.73	7.12
06.14	9.77	06.46	9.23	06.78	8.70	07.10	8.17	07.42	7.63	07.74	7.10
06.15	9.75	06.47	9.22	06.79	8.68	07.11	8.15	07.43	7.62	07.75	7.08
06.16	9.73	06.48	9.20	06.80	8.67	07.12	8.13	07.44	7.60	07.76	7.07
06.17	9.72	06.49	9.18	06.81	8.65	07.13	8.12	07.45	7.58	07.77	7.05
06.18	9.70	06.50	9.17	06.82	8.63	07.14	8.10	07.46	7.57	07.78	7.03
06.19	9.68	06.51	9.15	06.83	8.62	07.15	8.08	07.47	7.55	07.79	7.02
06.20	9.67	06.52	9.13	06.84	8.60	07.16	8.07	07.48	7.53	07.80	7.00
06.21	9.65	06.53	9.12	06.85	8.58	07.17	8.05	07.49	7.52	07.81	6.98
06.22	9.63	06.54	9.10	06.86	8.57	07.18	8.03	07.50	7.50	07.82	6.97
06.23	9.62	06.55	9.08	06.87	8.55	07.19	8.02	07.51	7.48	07.83	6.95
06.24	9.60	06.56	9.07	06.88	8.53	07.20	8.00	07.52	7.47	07.84	6.93
06.25	9.58	06.57	9.05	06.89	8.52	07.21	7.98	07.53	7.45	07.85	6.92
06.26	9.57	06.58	9.03	06.90	8.50	07.22	7.97	07.54	7.43	07.86	6.90
06.27	9.55	06.59	9.02	06.91	8.48	07.23	7.95	07.55	7.42	07.87	6.88
06.28	9.53	06.60	9.00	06.92	8.47	07.24	7.93	07.56	7.40	07.88	6.87
06.29	9.52	06.61	8.98	06.93	8.45	07.25	7.92	07.57	7.38	07.89	6.85
06.30	9.50	06.62	8.97	06.94	8.43	07.26	7.90	07.58	7.37	07.90	6.83



07.91	6.82	08.31	6.15	08.71	5.48	09.11	4.82	09.51	4.15	09.91	3.48
07.92	6.80	08.32	6.13	08.72	5.47	09.12	4.80	09.52	4.13	09.92	3.47
07.93	6.78	08.33	6.12	08.73	5.45	09.13	4.78	09.53	4.12	09.93	3.45
07.94	6.77	08.34	6.10	08.74	5.43	09.14	4.77	09.54	4.10	09.94	3.43
07.95	6.75	08.35	6.08	08.75	5.42	09.15	4.75	09.55	4.08	09.95	3.42
07.96	6.73	08.36	6.07	08.76	5.40	09.16	4.73	09.56	4.07	09.96	3.40
07.97	6.72	08.37	6.05	08.77	5.38	09.17	4.72	09.57	4.05	09.97	3.38
07.98	6.70	08.38	6.03	08.78	5.37	09.18	4.70	09.58	4.03	09.98	3.37
07.99	6.68	08.39	6.02	08.79	5.35	09.19	4.68	09.59	4.02	09.99	3.35
08.00	6.67	08.40	6.00	08.80	5.33	09.20	4.67	09.60	4.00	10.00	3.33
08.01	6.65	08.41	5.98	08.81	5.32	09.21	4.65	09.61	3.98	10.01	3.32
08.02	6.63	08.42	5.97	08.82	5.30	09.22	4.63	09.62	3.97	10.02	3.30
08.03	6.62	08.43	5.95	08.83	5.28	09.23	4.62	09.63	3.95	10.03	3.28
08.04	6.60	08.44	5.93	08.84	5.27	09.24	4.60	09.64	3.93	10.04	3.27
08.05	6.58	08.45	5.92	08.85	5.25	09.25	4.58	09.65	3.92	10.05	3.25
08.06	6.57	08.46	5.90	08.86	5.23	09.26	4.57	09.66	3.90	10.06	3.23
08.07	6.55	08.47	5.88	08.87	5.22	09.27	4.55	09.67	3.88	10.07	3.22
08.08	6.53	08.48	5.87	08.88	5.20	09.28	4.53	09.68	3.87	10.08	3.20
08.09	6.52	08.49	5.85	08.89	5.18	09.29	4.52	09.69	3.85	10.09	3.18
08.10	6.50	08.50	5.83	08.90	5.17	09.30	4.50	09.70	3.83	10.10	3.17
08.11	6.48	08.51	5.82	08.91	5.15	09.31	4.48	09.71	3.82	10.11	3.15
08.12	6.47	08.52	5.80	08.92	5.13	09.32	4.47	09.72	3.80	10.12	3.13
08.13	6.45	08.53	5.78	08.93	5.12	09.33	4.45	09.73	3.78	10.13	3.12
08.14	6.43	08.54	5.77	08.94	5.10	09.34	4.43	09.74	3.77	10.14	3.10
08.15	6.42	08.55	5.75	08.95	5.08	09.35	4.42	09.75	3.75	10.15	3.08
08.16	6.40	08.56	5.73	08.96	5.07	09.36	4.40	09.76	3.73	10.16	3.07
08.17	6.38	08.57	5.72	08.97	5.05	09.37	4.38	09.77	3.72	10.17	3.05
08.18	6.37	08.58	5.70	08.98	5.03	09.38	4.37	09.78	3.70	10.18	3.03
08.19	6.35	08.59	5.68	08.99	5.02	09.39	4.35	09.79	3.68	10.19	3.02
08.20	6.33	08.60	5.67	09.00	5.00	09.40	4.33	09.80	3.67	10.20	3.00
08.21	6.32	08.61	5.65	09.01	4.98	09.41	4.32	09.81	3.65	10.21	2.98
08.22	6.30	08.62	5.63	09.02	4.97	09.42	4.30	09.82	3.63	10.22	2.97
08.23	6.28	08.63	5.62	09.03	4.95	09.43	4.28	09.83	3.62	10.23	2.95
08.24	6.27	08.64	5.60	09.04	4.93	09.44	4.27	09.84	3.60	10.24	2.93
08.25	6.25	08.65	5.58	09.05	4.92	09.45	4.25	09.85	3.58	10.25	2.92
08.26	6.23	08.66	5.57	09.06	4.90	09.46	4.23	09.86	3.57	10.26	2.90
08.27	6.22	08.67	5.55	09.07	4.88	09.47	4.22	09.87	3.55	10.27	2.88
08.28	6.20	08.68	5.53	09.08	4.87	09.48	4.20	09.88	3.53	10.28	2.87
08.29	6.18	08.69	5.52	09.09	4.85	09.49	4.18	09.89	3.52	10.29	2.85
08.30	6.17	08.70	5.50	09.10	4.83	09.50	4.17	09.90	3.50	10.30	2.83



10.31	2.82	10.60	2.33	10.89	1.85	11.18	1.37	11.47	0.88	11.76	0.40
10.32	2.80	10.61	2.32	10.90	1.83	11.19	1.35	11.48	0.87	11.77	0.38
10.33	2.78	10.62	2.30	10.91	1.82	11.20	1.33	11.49	0.85	11.78	0.37
10.34	2.77	10.63	2.28	10.92	1.80	11.21	1.32	11.50	0.83	11.79	0.35
10.35	2.75	10.64	2.27	10.93	1.78	11.22	1.30	11.51	0.82	11.80	0.33
10.36	2.73	10.65	2.25	10.94	1.77	11.23	1.28	11.52	0.80	11.81	0.32
10.37	2.72	10.66	2.23	10.95	1.75	11.24	1.27	11.53	0.78	11.82	0.30
10.38	2.70	10.67	2.22	10.96	1.73	11.25	1.25	11.54	0.77	11.83	0.28
10.39	2.68	10.68	2.20	10.97	1.72	11.26	1.23	11.55	0.75	11.84	0.27
10.40	2.67	10.69	2.18	10.98	1.70	11.27	1.22	11.56	0.73	11.85	0.25
10.41	2.65	10.70	2.17	10.99	1.68	11.28	1.20	11.57	0.72	11.86	0.23
10.42	2.63	10.71	2.15	11.00	1.67	11.29	1.18	11.58	0.70	11.87	0.22
10.43	2.62	10.72	2.13	11.01	1.65	11.30	1.17	11.59	0.68	11.88	0.20
10.44	2.60	10.73	2.12	11.02	1.63	11.31	1.15	11.60	0.67	11.89	0.18
10.45	2.58	10.74	2.10	11.03	1.62	11.32	1.13	11.61	0.65	11.90	0.17
10.46	2.57	10.75	2.08	11.04	1.60	11.33	1.12	11.62	0.63	11.91	0.15
10.47	2.55	10.76	2.07	11.05	1.58	11.34	1.10	11.63	0.62	11.92	0.13
10.48	2.53	10.77	2.05	11.06	1.57	11.35	1.08	11.64	0.60	11.93	0.12
10.49	2.52	10.78	2.03	11.07	1.55	11.36	1.07	11.65	0.58	11.94	0.10
10.50	2.50	10.79	2.02	11.08	1.53	11.37	1.05	11.66	0.57	11.95	0.08
10.51	2.48	10.80	2.00	11.09	1.52	11.38	1.03	11.67	0.55	11.96	0.07
10.52	2.47	10.81	1.98	11.10	1.50	11.39	1.02	11.68	0.53	11.97	0.05
10.53	2.45	10.82	1.97	11.11	1.48	11.40	1.00	11.69	0.52	11.98	0.03
10.54	2.43	10.83	1.95	11.12	1.47	11.41	0.98	11.70	0.50	11.99	0.02
10.55	2.42	10.84	1.93	11.13	1.45	11.42	0.97	11.71	0.48	12.00	0.00
10.56	2.40	10.85	1.92	11.14	1.43	11.43	0.95	11.72	0.47		
10.57	2.38	10.86	1.90	11.15	1.42	11.44	0.93	11.73	0.45		
10.58	2.37	10.87	1.88	11.16	1.40	11.45	0.92	11.74	0.43		
10.59	2.35	10.88	1.87	11.17	1.38	11.46	0.90	11.75	0.42		



S12 Appendix 5: Time table P3 Pace Race 150 m

The marks for any time in seconds (two decimals) are calculated with the following formula:

$$22.00 - t$$

where t = the time of the fastest run in the appropriate number of decimals

Marks cannot be higher than 10.00 or lower than 0.00.

Time	Mark	12.31	9.69	12.63	9.37	12.95	9.05	13.27	8.73	13.59	8.41
12.00	10.00	12.32	9.68	12.64	9.36	12.96	9.04	13.28	8.72	13.60	8.40
12.01	9.99	12.33	9.67	12.65	9.35	12.97	9.03	13.29	8.71	13.61	8.39
12.02	9.98	12.34	9.66	12.66	9.34	12.98	9.02	13.30	8.70	13.62	8.38
12.03	9.97	12.35	9.65	12.67	9.33	12.99	9.01	13.31	8.69	13.63	8.37
12.04	9.96	12.36	9.64	12.68	9.32	13.00	9.00	13.32	8.68	13.64	8.36
12.05	9.95	12.37	9.63	12.69	9.31	13.01	8.99	13.33	8.67	13.65	8.35
12.06	9.94	12.38	9.62	12.70	9.30	13.02	8.98	13.34	8.66	13.66	8.34
12.07	9.93	12.39	9.61	12.71	9.29	13.03	8.97	13.35	8.65	13.67	8.33
12.08	9.92	12.40	9.60	12.72	9.28	13.04	8.96	13.36	8.64	13.68	8.32
12.09	9.91	12.41	9.59	12.73	9.27	13.05	8.95	13.37	8.63	13.69	8.31
12.10	9.90	12.42	9.58	12.74	9.26	13.06	8.94	13.38	8.62	13.70	8.30
12.11	9.89	12.43	9.57	12.75	9.25	13.07	8.93	13.39	8.61	13.71	8.29
12.12	9.88	12.44	9.56	12.76	9.24	13.08	8.92	13.40	8.60	13.72	8.28
12.13	9.87	12.45	9.55	12.77	9.23	13.09	8.91	13.41	8.59	13.73	8.27
12.14	9.86	12.46	9.54	12.78	9.22	13.10	8.90	13.42	8.58	13.74	8.26
12.15	9.85	12.47	9.53	12.79	9.21	13.11	8.89	13.43	8.57	13.75	8.25
12.16	9.84	12.48	9.52	12.80	9.20	13.12	8.88	13.44	8.56	13.76	8.24
12.17	9.83	12.49	9.51	12.81	9.19	13.13	8.87	13.45	8.55	13.77	8.23
12.18	9.82	12.50	9.50	12.82	9.18	13.14	8.86	13.46	8.54	13.78	8.22
12.19	9.81	12.51	9.49	12.83	9.17	13.15	8.85	13.47	8.53	13.79	8.21
12.20	9.80	12.52	9.48	12.84	9.16	13.16	8.84	13.48	8.52	13.80	8.20
12.21	9.79	12.53	9.47	12.85	9.15	13.17	8.83	13.49	8.51	13.81	8.19
12.22	9.78	12.54	9.46	12.86	9.14	13.18	8.82	13.50	8.50	13.82	8.18
12.23	9.77	12.55	9.45	12.87	9.13	13.19	8.81	13.51	8.49	13.83	8.17
12.24	9.76	12.56	9.44	12.88	9.12	13.20	8.80	13.52	8.48	13.84	8.16
12.25	9.75	12.57	9.43	12.89	9.11	13.21	8.79	13.53	8.47	13.85	8.15
12.26	9.74	12.58	9.42	12.90	9.10	13.22	8.78	13.54	8.46	13.86	8.14
12.27	9.73	12.59	9.41	12.91	9.09	13.23	8.77	13.55	8.45	13.87	8.13
12.28	9.72	12.60	9.40	12.92	9.08	13.24	8.76	13.56	8.44	13.88	8.12
12.29	9.71	12.61	9.39	12.93	9.07	13.25	8.75	13.57	8.43	13.89	8.11
12.30	9.70	12.62	9.38	12.94	9.06	13.26	8.74	13.58	8.42	13.90	8.10



13.91	8.09	14.31	7.69	14.71	7.29	15.11	6.89	15.51	6.49	15.91	6.09
13.92	8.08	14.32	7.68	14.72	7.28	15.12	6.88	15.52	6.48	15.92	6.08
13.93	8.07	14.33	7.67	14.73	7.27	15.13	6.87	15.53	6.47	15.93	6.07
13.94	8.06	14.34	7.66	14.74	7.26	15.14	6.86	15.54	6.46	15.94	6.06
13.95	8.05	14.35	7.65	14.75	7.25	15.15	6.85	15.55	6.45	15.95	6.05
13.96	8.04	14.36	7.64	14.76	7.24	15.16	6.84	15.56	6.44	15.96	6.04
13.97	8.03	14.37	7.63	14.77	7.23	15.17	6.83	15.57	6.43	15.97	6.03
13.98	8.02	14.38	7.62	14.78	7.22	15.18	6.82	15.58	6.42	15.98	6.02
13.99	8.01	14.39	7.61	14.79	7.21	15.19	6.81	15.59	6.41	15.99	6.01
14.00	8.00	14.40	7.60	14.80	7.20	15.20	6.80	15.60	6.40	16.00	6.00
14.01	7.99	14.41	7.59	14.81	7.19	15.21	6.79	15.61	6.39	16.01	5.99
14.02	7.98	14.42	7.58	14.82	7.18	15.22	6.78	15.62	6.38	16.02	5.98
14.03	7.97	14.43	7.57	14.83	7.17	15.23	6.77	15.63	6.37	16.03	5.97
14.04	7.96	14.44	7.56	14.84	7.16	15.24	6.76	15.64	6.36	16.04	5.96
14.05	7.95	14.45	7.55	14.85	7.15	15.25	6.75	15.65	6.35	16.05	5.95
14.06	7.94	14.46	7.54	14.86	7.14	15.26	6.74	15.66	6.34	16.06	5.94
14.07	7.93	14.47	7.53	14.87	7.13	15.27	6.73	15.67	6.33	16.07	5.93
14.08	7.92	14.48	7.52	14.88	7.12	15.28	6.72	15.68	6.32	16.08	5.92
14.09	7.91	14.49	7.51	14.89	7.11	15.29	6.71	15.69	6.31	16.09	5.91
14.10	7.90	14.50	7.50	14.90	7.10	15.30	6.70	15.70	6.30	16.10	5.90
14.11	7.89	14.51	7.49	14.91	7.09	15.31	6.69	15.71	6.29	16.11	5.89
14.12	7.88	14.52	7.48	14.92	7.08	15.32	6.68	15.72	6.28	16.12	5.88
14.13	7.87	14.53	7.47	14.93	7.07	15.33	6.67	15.73	6.27	16.13	5.87
14.14	7.86	14.54	7.46	14.94	7.06	15.34	6.66	15.74	6.26	16.14	5.86
14.15	7.85	14.55	7.45	14.95	7.05	15.35	6.65	15.75	6.25	16.15	5.85
14.16	7.84	14.56	7.44	14.96	7.04	15.36	6.64	15.76	6.24	16.16	5.84
14.17	7.83	14.57	7.43	14.97	7.03	15.37	6.63	15.77	6.23	16.17	5.83
14.18	7.82	14.58	7.42	14.98	7.02	15.38	6.62	15.78	6.22	16.18	5.82
14.19	7.81	14.59	7.41	14.99	7.01	15.39	6.61	15.79	6.21	16.19	5.81
14.20	7.80	14.60	7.40	15.00	7.00	15.40	6.60	15.80	6.20	16.20	5.80
14.21	7.79	14.61	7.39	15.01	6.99	15.41	6.59	15.81	6.19	16.21	5.79
14.22	7.78	14.62	7.38	15.02	6.98	15.42	6.58	15.82	6.18	16.22	5.78
14.23	7.77	14.63	7.37	15.03	6.97	15.43	6.57	15.83	6.17	16.23	5.77
14.24	7.76	14.64	7.36	15.04	6.96	15.44	6.56	15.84	6.16	16.24	5.76
14.25	7.75	14.65	7.35	15.05	6.95	15.45	6.55	15.85	6.15	16.25	5.75
14.26	7.74	14.66	7.34	15.06	6.94	15.46	6.54	15.86	6.14	16.26	5.74
14.27	7.73	14.67	7.33	15.07	6.93	15.47	6.53	15.87	6.13	16.27	5.73
14.28	7.72	14.68	7.32	15.08	6.92	15.48	6.52	15.88	6.12	16.28	5.72
14.29	7.71	14.69	7.31	15.09	6.91	15.49	6.51	15.89	6.11	16.29	5.71
14.30	7.70	14.70	7.30	15.10	6.90	15.50	6.50	15.90	6.10	16.30	5.70



16.31	5.69	16.71	5.29	17.11	4.89	17.51	4.49	17.91	4.09	18.31	3.69
16.32	5.68	16.72	5.28	17.12	4.88	17.52	4.48	17.92	4.08	18.32	3.68
16.33	5.67	16.73	5.27	17.13	4.87	17.53	4.47	17.93	4.07	18.33	3.67
16.34	5.66	16.74	5.26	17.14	4.86	17.54	4.46	17.94	4.06	18.34	3.66
16.35	5.65	16.75	5.25	17.15	4.85	17.55	4.45	17.95	4.05	18.35	3.65
16.36	5.64	16.76	5.24	17.16	4.84	17.56	4.44	17.96	4.04	18.36	3.64
16.37	5.63	16.77	5.23	17.17	4.83	17.57	4.43	17.97	4.03	18.37	3.63
16.38	5.62	16.78	5.22	17.18	4.82	17.58	4.42	17.98	4.02	18.38	3.62
16.39	5.61	16.79	5.21	17.19	4.81	17.59	4.41	17.99	4.01	18.39	3.61
16.40	5.60	16.80	5.20	17.20	4.80	17.60	4.40	18.00	4.00	18.40	3.60
16.41	5.59	16.81	5.19	17.21	4.79	17.61	4.39	18.01	3.99	18.41	3.59
16.42	5.58	16.82	5.18	17.22	4.78	17.62	4.38	18.02	3.98	18.42	3.58
16.43	5.57	16.83	5.17	17.23	4.77	17.63	4.37	18.03	3.97	18.43	3.57
16.44	5.56	16.84	5.16	17.24	4.76	17.64	4.36	18.04	3.96	18.44	3.56
16.45	5.55	16.85	5.15	17.25	4.75	17.65	4.35	18.05	3.95	18.45	3.55
16.46	5.54	16.86	5.14	17.26	4.74	17.66	4.34	18.06	3.94	18.46	3.54
16.47	5.53	16.87	5.13	17.27	4.73	17.67	4.33	18.07	3.93	18.47	3.53
16.48	5.52	16.88	5.12	17.28	4.72	17.68	4.32	18.08	3.92	18.48	3.52
16.49	5.51	16.89	5.11	17.29	4.71	17.69	4.31	18.09	3.91	18.49	3.51
16.50	5.50	16.90	5.10	17.30	4.70	17.70	4.30	18.10	3.90	18.50	3.50
16.51	5.49	16.91	5.09	17.31	4.69	17.71	4.29	18.11	3.89	18.51	3.49
16.52	5.48	16.92	5.08	17.32	4.68	17.72	4.28	18.12	3.88	18.52	3.48
16.53	5.47	16.93	5.07	17.33	4.67	17.73	4.27	18.13	3.87	18.53	3.47
16.54	5.46	16.94	5.06	17.34	4.66	17.74	4.26	18.14	3.86	18.54	3.46
16.55	5.45	16.95	5.05	17.35	4.65	17.75	4.25	18.15	3.85	18.55	3.45
16.56	5.44	16.96	5.04	17.36	4.64	17.76	4.24	18.16	3.84	18.56	3.44
16.57	5.43	16.97	5.03	17.37	4.63	17.77	4.23	18.17	3.83	18.57	3.43
16.58	5.42	16.98	5.02	17.38	4.62	17.78	4.22	18.18	3.82	18.58	3.42
16.59	5.41	16.99	5.01	17.39	4.61	17.79	4.21	18.19	3.81	18.59	3.41
16.60	5.40	17.00	5.00	17.40	4.60	17.80	4.20	18.20	3.80	18.60	3.40
16.61	5.39	17.01	4.99	17.41	4.59	17.81	4.19	18.21	3.79	18.61	3.39
16.62	5.38	17.02	4.98	17.42	4.58	17.82	4.18	18.22	3.78	18.62	3.38
16.63	5.37	17.03	4.97	17.43	4.57	17.83	4.17	18.23	3.77	18.63	3.37
16.64	5.36	17.04	4.96	17.44	4.56	17.84	4.16	18.24	3.76	18.64	3.36
16.65	5.35	17.05	4.95	17.45	4.55	17.85	4.15	18.25	3.75	18.65	3.35
16.66	5.34	17.06	4.94	17.46	4.54	17.86	4.14	18.26	3.74	18.66	3.34
16.67	5.33	17.07	4.93	17.47	4.53	17.87	4.13	18.27	3.73	18.67	3.33
16.68	5.32	17.08	4.92	17.48	4.52	17.88	4.12	18.28	3.72	18.68	3.32
16.69	5.31	17.09	4.91	17.49	4.51	17.89	4.11	18.29	3.71	18.69	3.31
16.70	5.30	17.10	4.90	17.50	4.50	17.90	4.10	18.30	3.70	18.70	3.30



18.71	3.29	19.11	2.89	19.51	2.49	19.91	2.09	20.31	1.69	20.71	1.29
18.72	3.28	19.12	2.88	19.52	2.48	19.92	2.08	20.32	1.68	20.72	1.28
18.73	3.27	19.13	2.87	19.53	2.47	19.93	2.07	20.33	1.67	20.73	1.27
18.74	3.26	19.14	2.86	19.54	2.46	19.94	2.06	20.34	1.66	20.74	1.26
18.75	3.25	19.15	2.85	19.55	2.45	19.95	2.05	20.35	1.65	20.75	1.25
18.76	3.24	19.16	2.84	19.56	2.44	19.96	2.04	20.36	1.64	20.76	1.24
18.77	3.23	19.17	2.83	19.57	2.43	19.97	2.03	20.37	1.63	20.77	1.23
18.78	3.22	19.18	2.82	19.58	2.42	19.98	2.02	20.38	1.62	20.78	1.22
18.79	3.21	19.19	2.81	19.59	2.41	19.99	2.01	20.39	1.61	20.79	1.21
18.80	3.20	19.20	2.80	19.60	2.40	20.00	2.00	20.40	1.60	20.80	1.20
18.81	3.19	19.21	2.79	19.61	2.39	20.01	1.99	20.41	1.59	20.81	1.19
18.82	3.18	19.22	2.78	19.62	2.38	20.02	1.98	20.42	1.58	20.82	1.18
18.83	3.17	19.23	2.77	19.63	2.37	20.03	1.97	20.43	1.57	20.83	1.17
18.84	3.16	19.24	2.76	19.64	2.36	20.04	1.96	20.44	1.56	20.84	1.16
18.85	3.15	19.25	2.75	19.65	2.35	20.05	1.95	20.45	1.55	20.85	1.15
18.86	3.14	19.26	2.74	19.66	2.34	20.06	1.94	20.46	1.54	20.86	1.14
18.87	3.13	19.27	2.73	19.67	2.33	20.07	1.93	20.47	1.53	20.87	1.13
18.88	3.12	19.28	2.72	19.68	2.32	20.08	1.92	20.48	1.52	20.88	1.12
18.89	3.11	19.29	2.71	19.69	2.31	20.09	1.91	20.49	1.51	20.89	1.11
18.90	3.10	19.30	2.70	19.70	2.30	20.10	1.90	20.50	1.50	20.90	1.10
18.91	3.09	19.31	2.69	19.71	2.29	20.11	1.89	20.51	1.49	20.91	1.09
18.92	3.08	19.32	2.68	19.72	2.28	20.12	1.88	20.52	1.48	20.92	1.08
18.93	3.07	19.33	2.67	19.73	2.27	20.13	1.87	20.53	1.47	20.93	1.07
18.94	3.06	19.34	2.66	19.74	2.26	20.14	1.86	20.54	1.46	20.94	1.06
18.95	3.05	19.35	2.65	19.75	2.25	20.15	1.85	20.55	1.45	20.95	1.05
18.96	3.04	19.36	2.64	19.76	2.24	20.16	1.84	20.56	1.44	20.96	1.04
18.97	3.03	19.37	2.63	19.77	2.23	20.17	1.83	20.57	1.43	20.97	1.03
18.98	3.02	19.38	2.62	19.78	2.22	20.18	1.82	20.58	1.42	20.98	1.02
18.99	3.01	19.39	2.61	19.79	2.21	20.19	1.81	20.59	1.41	20.99	1.01
19.00	3.00	19.40	2.60	19.80	2.20	20.20	1.80	20.60	1.40	21.00	1.00
19.01	2.99	19.41	2.59	19.81	2.19	20.21	1.79	20.61	1.39	21.01	0.99
19.02	2.98	19.42	2.58	19.82	2.18	20.22	1.78	20.62	1.38	21.02	0.98
19.03	2.97	19.43	2.57	19.83	2.17	20.23	1.77	20.63	1.37	21.03	0.97
19.04	2.96	19.44	2.56	19.84	2.16	20.24	1.76	20.64	1.36	21.04	0.96
19.05	2.95	19.45	2.55	19.85	2.15	20.25	1.75	20.65	1.35	21.05	0.95
19.06	2.94	19.46	2.54	19.86	2.14	20.26	1.74	20.66	1.34	21.06	0.94
19.07	2.93	19.47	2.53	19.87	2.13	20.27	1.73	20.67	1.33	21.07	0.93
19.08	2.92	19.48	2.52	19.88	2.12	20.28	1.72	20.68	1.32	21.08	0.92
19.09	2.91	19.49	2.51	19.89	2.11	20.29	1.71	20.69	1.31	21.09	0.91
19.10	2.90	19.50	2.50	19.90	2.10	20.30	1.70	20.70	1.30	21.10	0.90



21.11	0.89	21.51	0.49	21.91	0.09
21.12	0.88	21.52	0.48	21.92	0.08
21.13	0.87	21.53	0.47	21.93	0.07
21.14	0.86	21.54	0.46	21.94	0.06
21.15	0.85	21.55	0.45	21.95	0.05
21.16	0.84	21.56	0.44	21.96	0.04
21.17	0.83	21.57	0.43	21.97	0.03
21.18	0.82	21.58	0.42	21.98	0.02
21.19	0.81	21.59	0.41	21.99	0.01
21.20	0.80	21.60	0.40	22.00	0.00
21.21	0.79	21.61	0.39		
21.22	0.78	21.62	0.38		
21.23	0.77	21.63	0.37		
21.24	0.76	21.64	0.36		
21.25	0.75	21.65	0.35		
21.26	0.74	21.66	0.34		
21.27	0.73	21.67	0.33		
21.28	0.72	21.68	0.32		
21.29	0.71	21.69	0.31		
21.30	0.70	21.70	0.30		
21.31	0.69	21.71	0.29		
21.32	0.68	21.72	0.28		
21.33	0.67	21.73	0.27		
21.34	0.66	21.74	0.26		
21.35	0.65	21.75	0.25		
21.36	0.64	21.76	0.24		
21.37	0.63	21.77	0.23		
21.38	0.62	21.78	0.22		
21.39	0.61	21.79	0.21		
21.40	0.60	21.80	0.20		
21.41	0.59	21.81	0.19		
21.42	0.58	21.82	0.18		
21.43	0.57	21.83	0.17		
21.44	0.56	21.84	0.16		
21.45	0.55	21.85	0.15		
21.46	0.54	21.86	0.14		
21.47	0.53	21.87	0.13		
21.48	0.52	21.88	0.12		
21.49	0.51	21.89	0.11		
21.50	0.50	21.90	0.10		



S13 Appendix 6: Times for group tests and finals

When groups of riders are riding in the oval track on speaker's instructions, the time a specific section is shown is in according to the table set by the FEIF Sport Committee:

Section	Up to 3 riders	4 riders	5 riders	6 riders	7 or more riders
Lengthen stride T1/T3	100	110	110	110	120
Slow (speed)	90	100	110	120	130
Loose rein	90	90	90	90	110
Walk	85	90	95	100	105
Slow tölt T1/T3	85	90	95	100	105
Slow to medium speed	70	75	85	90	95
Any speed tölt	70	75	85	90	95
Trot	70	75	85	90	95
Fast tölt	60	65	70	75	80
Canter	60	65	70	75	80
Fast tölt T1/T3	50	55	60	65	70

All times in seconds



S14 Appendix 7: Ground work at events

The aim to allow groundwork is to enable riders to maintain the (training) form of their horse during the period they are present at events.

Groundwork here means: lunging a horse in a designated lunging area. Normal and common use of groundwork will be allowed and also training methods with the use of generally accepted lunging equipment would be allowed.

Allowed are:

- lunging rein or double lunging rein;
- the lunging lines may be connected directly to the bit/cavesson or through the lunging surcingle to the bit/cavesson or through the bit/cavesson to the lunging surcingle/roller;
- bridle with noseband and bit or cavesson;
- lunging surcingle/roller;
- with rings for the lunging lines;
- lunging whip with a length over the length allowed by G8.2.4;
- side reins with a direct (straight) connection between the bit/cavesson and the lunging surcingle/roller only;
- other equipment allowed by G8 and not in conflict with the aim of groundwork;
- the position of the 'rider' to the horse on the ground is optional.

Any use of other equipment or mechanical systems like chambon, gogue, chambogue, martingale, smart jock, 'Spanish Rider', (neck) stretchers or protective material over 250 g per foot, will not be allowed (these examples are not exhaustive).

If there are any doubts about equipment used, the chief judge will decide upon it.



S15 Appendix 8: Description of Start boxes

Size

- Width of the boxes 90-110 cm, preferably 95-100 cm
- Length inside the doors 190 – 220 cm, preferably 200-210 cm
- Height of the side panels at least 220cm above the ground, preferably 250cm
- Height of the front doors at least 220 cm above the ground, preferably 230 cm

Construction

Starting boxes shall be secure for horses, riders, helpers and judges with regard to construction and material, in no case there shall be sharp edges in the horse area

The starting box shall be fixed to avoid any shifting

Horses shall have a view through the front doors

The risk of trapping of the hooves in the front doors when the horse rears shall be avoided by an effective security device

Grids are not allowed in the front doors

If bars are used in the front doors they shall rise vertically inside the boxes

Secure and swift locking of back doors shall be guaranteed

Function

Front doors shall not swing back after opening (shall be checked by the chief judge before start of the event)

Vibrations and noise shall be minimized when opening the doors, in no case it should have an alarming effect on the horses

The judge in the start position shall have constant visual contact to horse and rider from his position

The release mechanism shall be constructed in such a way that electronic time keeping can be installed. Time keeping shall begin at the moment the front doors are triggered to open.



S16 Appendix 10: Drawings

The following drawings and diagrams represent the officially recognized track configurations for use in FEIF Sport Competition.

All of the drawings are available from the FEIF website as scalable PDF files which can be printed at any size.

The PDF versions of the drawings and diagrams include the necessary comments and descriptions to assist in track construction.

Drawings provided by

- CAT Design
- C.A. Trochsler,
- H. Pfaffen,
- D. Lautscham
- D. Smith



S16.1 Oval track 250 m / 4 m

Riding track:	250.00 m
Outer circumference:	271.69 m
Inner circumference:	246.56 m
Width	4.00 m

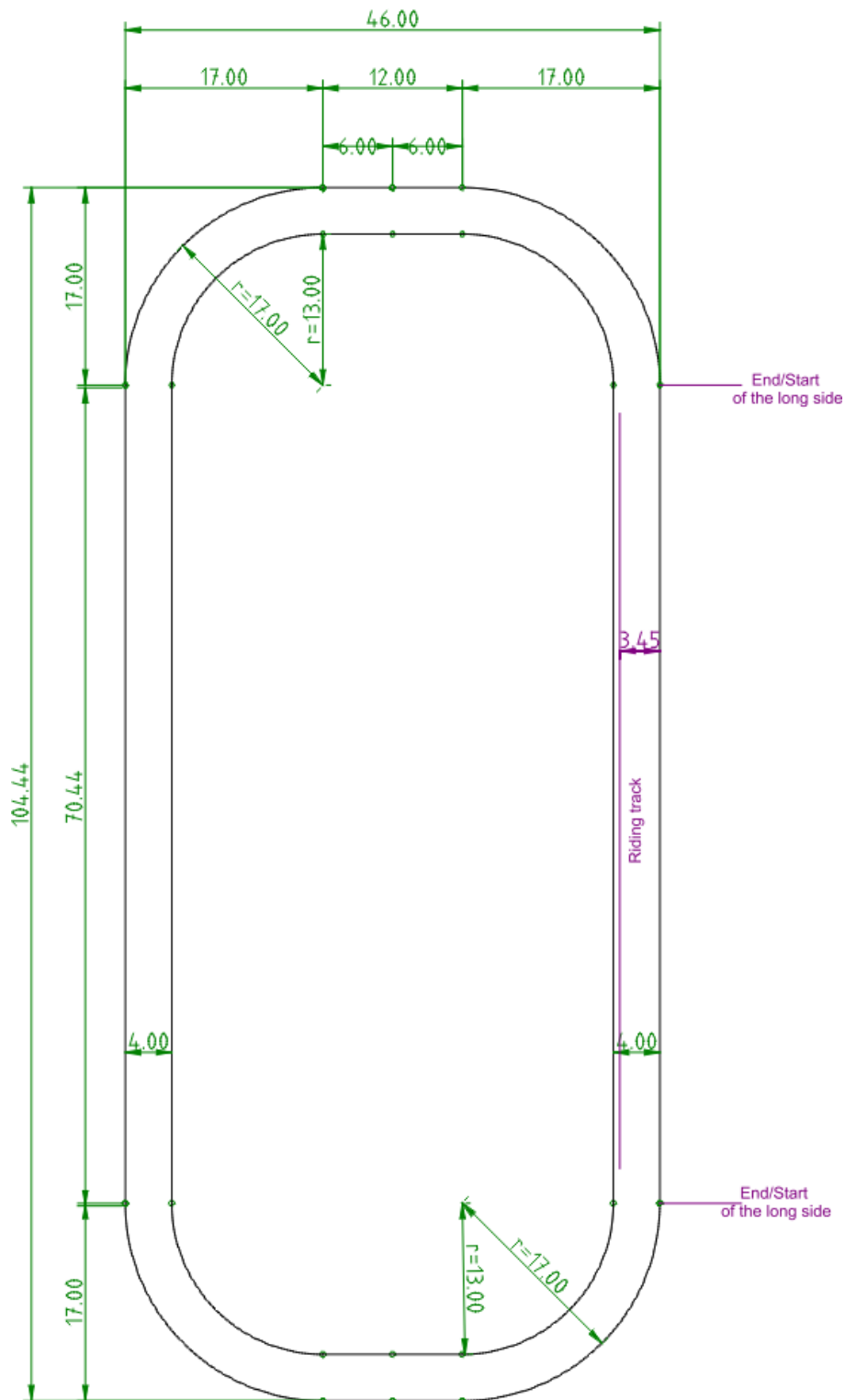

S16.2 Oval track 250 m / 6 m

Riding track:	250.00 m
Outer circumference:	284.21 m
Inner circumference:	246.52 m
Width	6.00 m

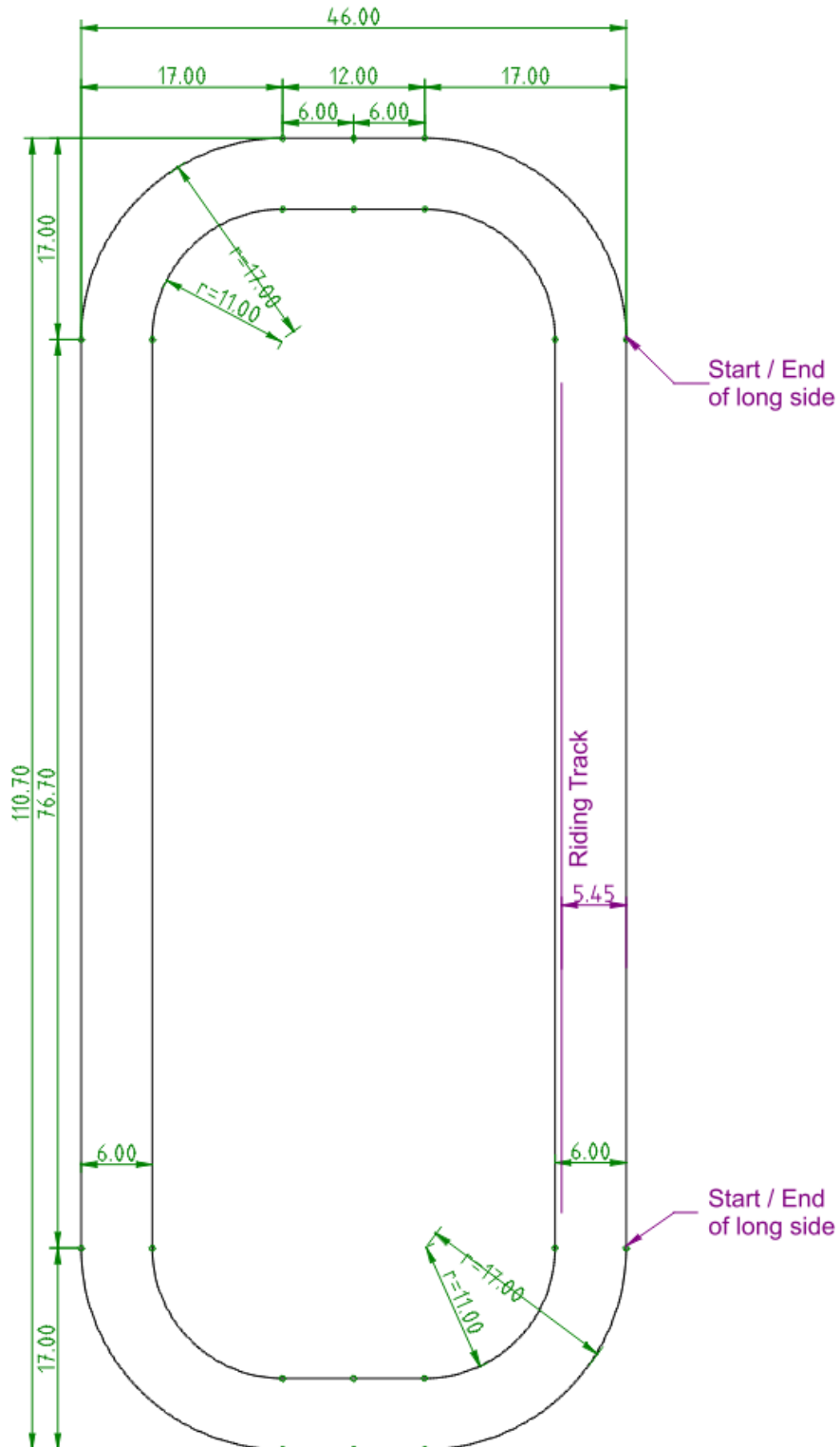

S16.4 Entering the oval track and beginning of the test

Enter and follow the way of the oval track up to any of short sides. However, the end short side may not be passed without the rider beginning the test. The rider must greet judges visibly by nodding his/her head thus indicating his/her beginning the test.

Possibilities of entering and beginning the test with the entry being at the long side:

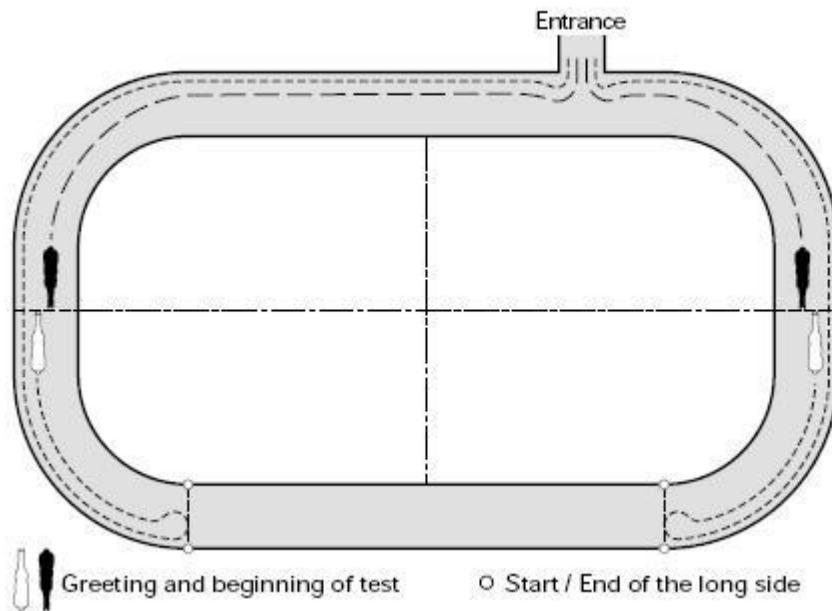

Possibilities of entering and beginning the test with the entry being at the short side:

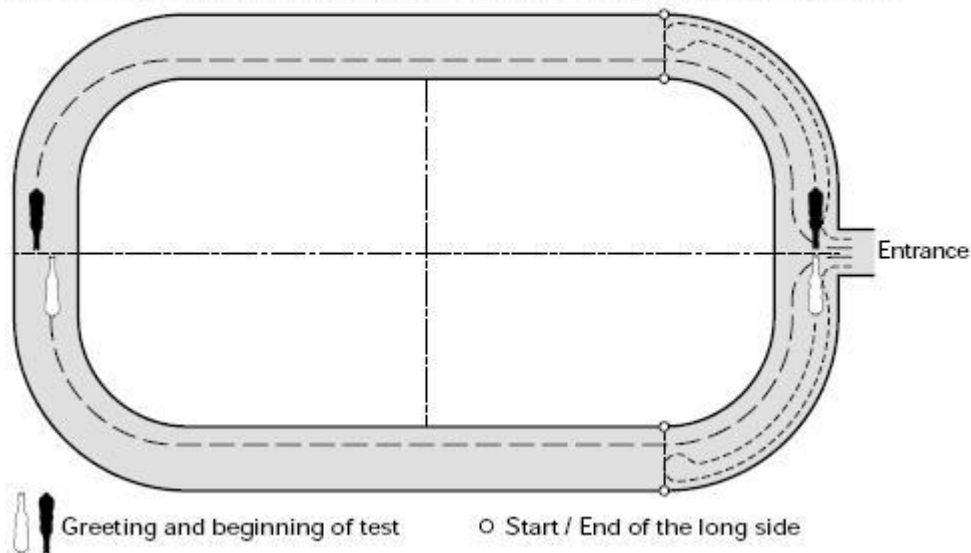

S16.5 Dressage arena

Judges judge at C.

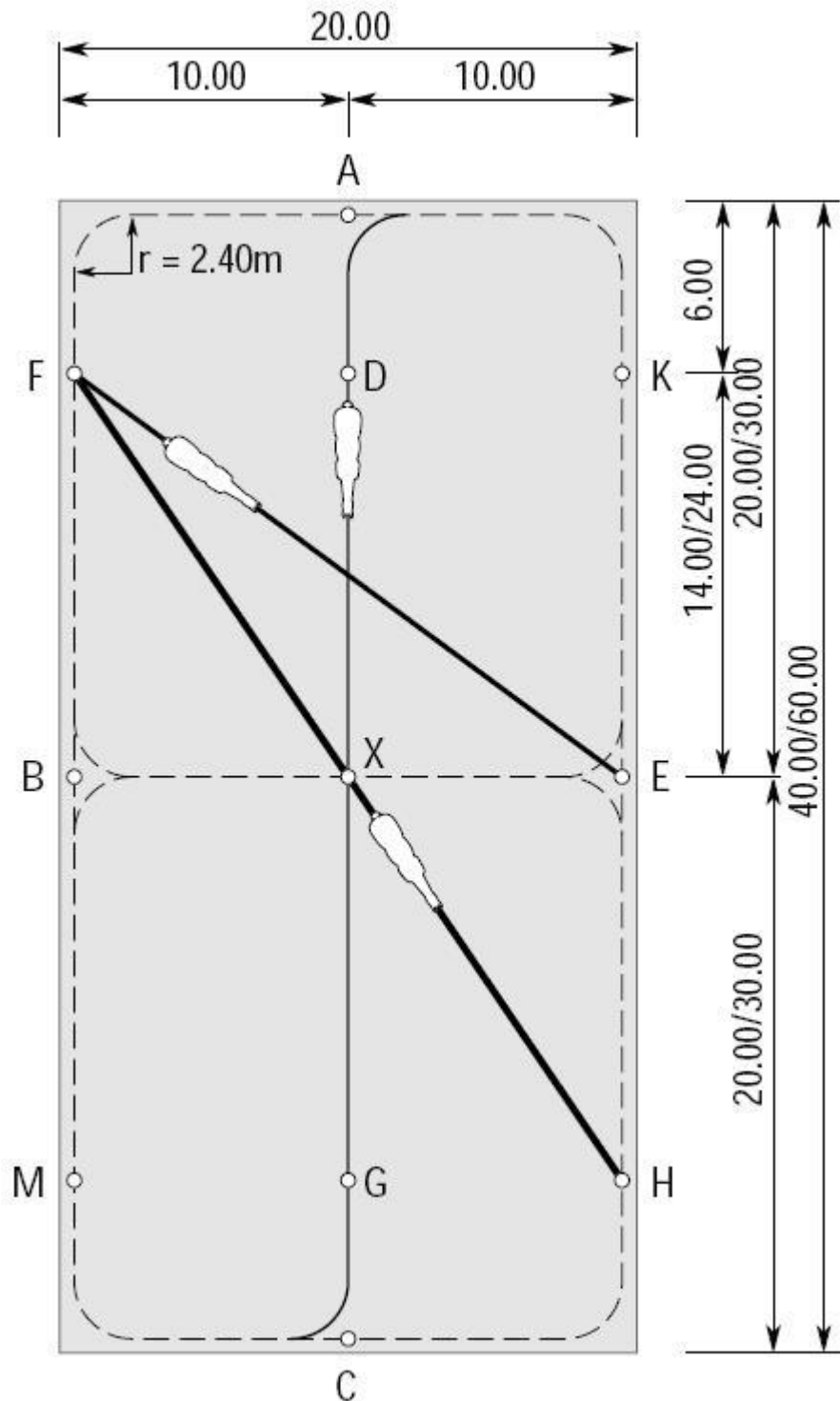

S16.6 Pace track environment

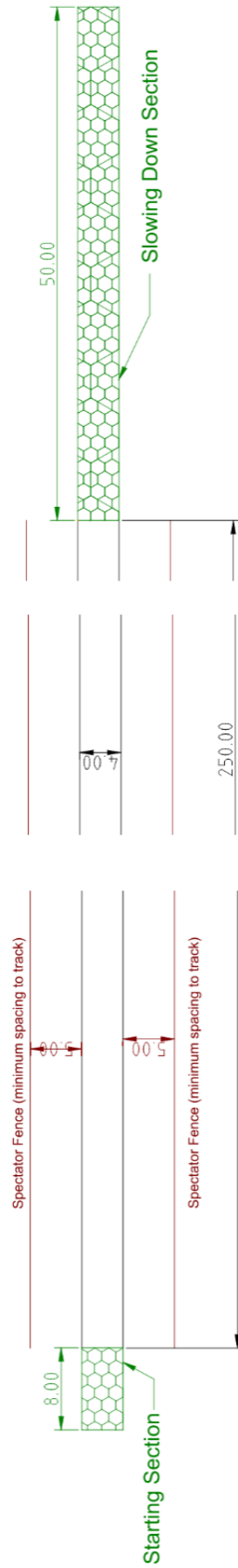

S16.7 Pace test track configuration



S16.8 P1 track configuration



Judging positions marked with **(PA)** may be replaced with Pace Assistants at WorldRanking tournaments. These positions must be occupied by FEIF licensed Judges at all International Competitions.

For WorldRanking tournaments at least five Judges must be used with at most four Pace Assistants.

An extra Judge or Pace Assistant must be added when start boxes are used.

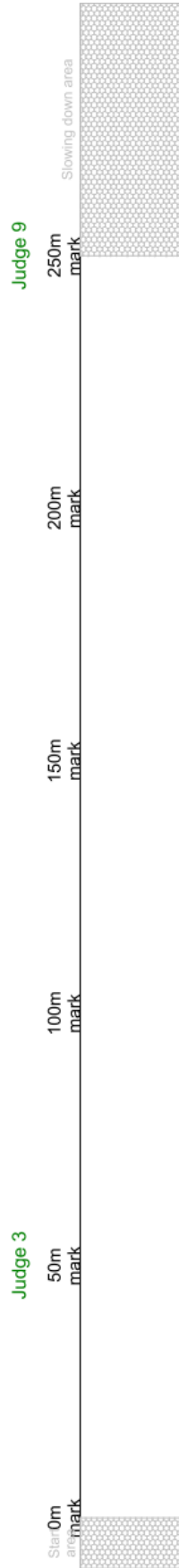

Judge 1 Judge 2 Judge 3 Judge 4 Judge 5 Judge 6 Judge 7 Judge 8 Judge 9 Judge 10 (PA)

Detail of Start Area when Starting Boxes are used:

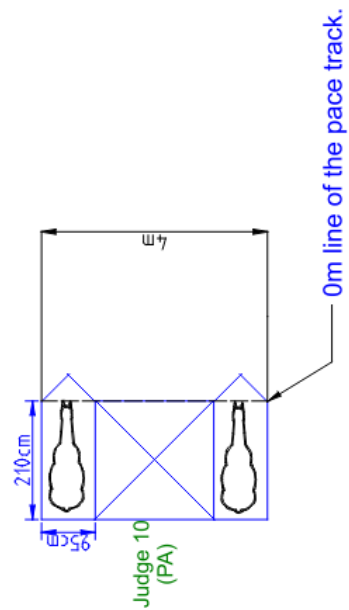

The dimensions shown for the starting box are the preferred sizes as published by the Sport Committee. The preferred height of the walls is 250cm. These are *not required dimensions*.

The start boxes must be positioned so the leading edge of the box (not the point of the doors) is on the "0" line of the pace track.

When electronic time keeping is used the time must be started by the same mechanism which starts the opening of the doors.

S16.9 P2 track configuration

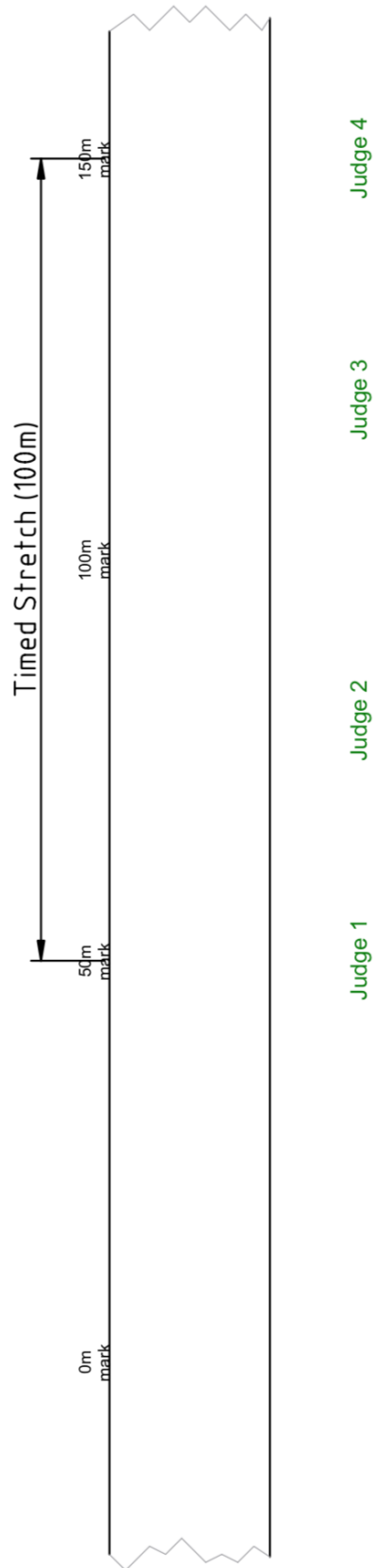

S16.10 Trail

The following exercises could be included:

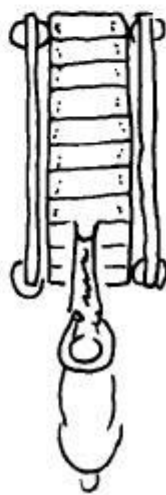
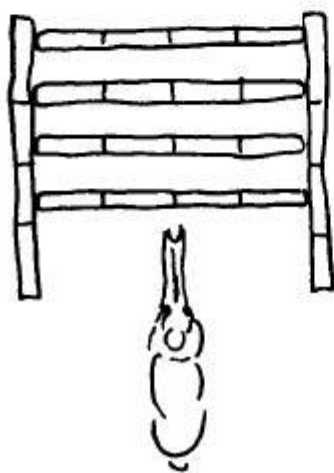
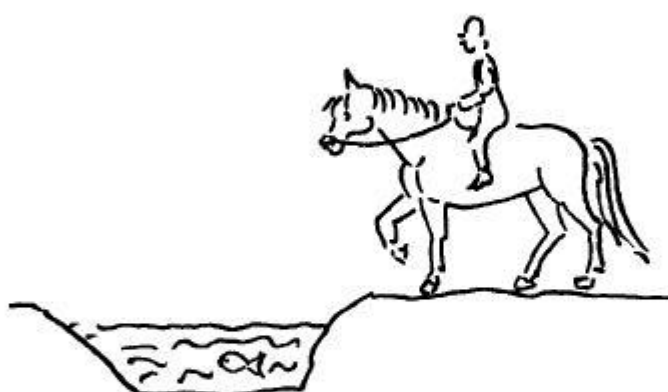
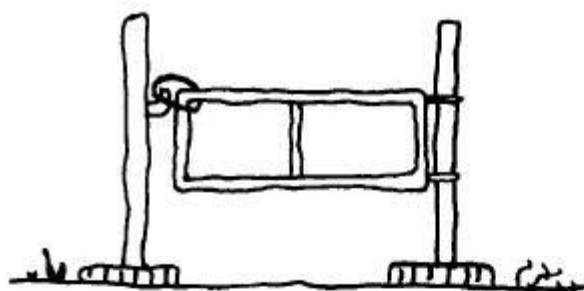

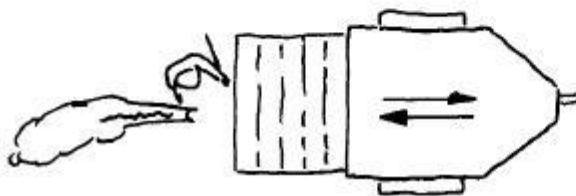
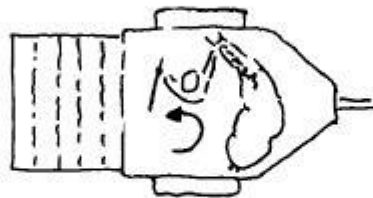
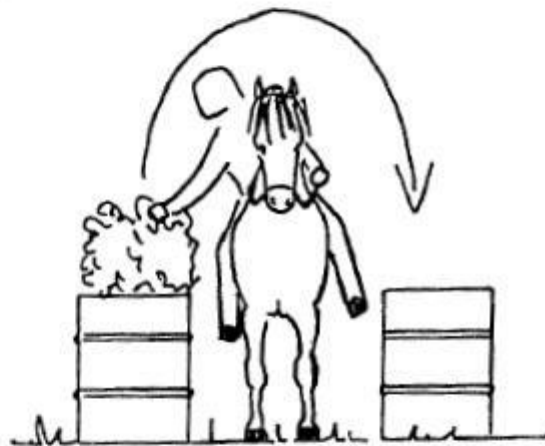
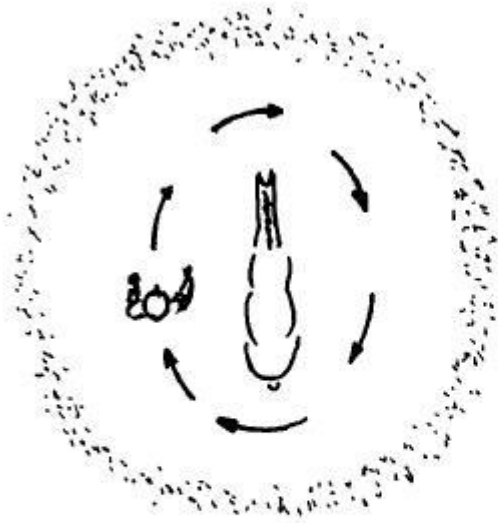

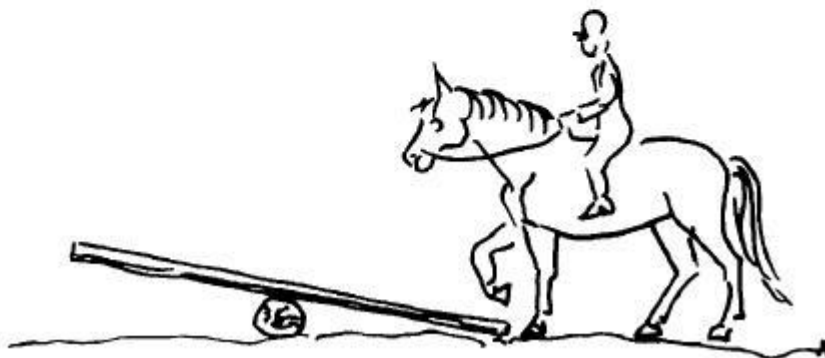
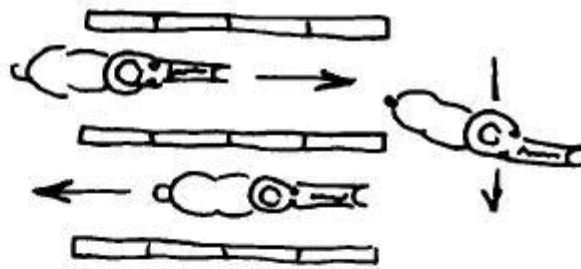
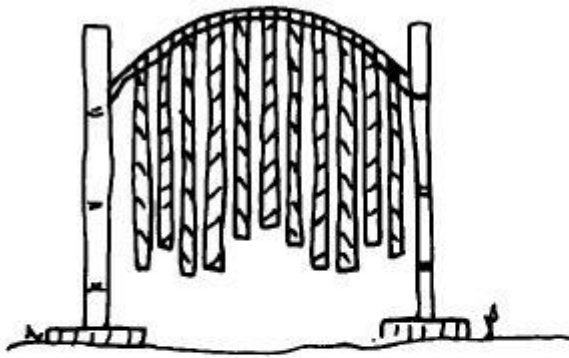

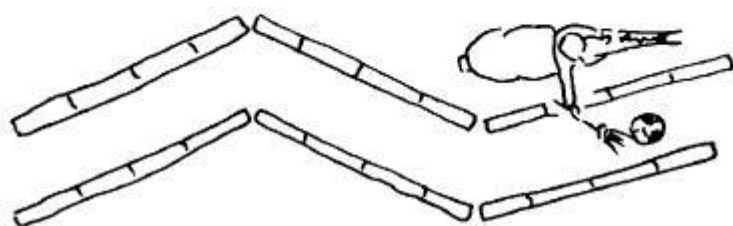
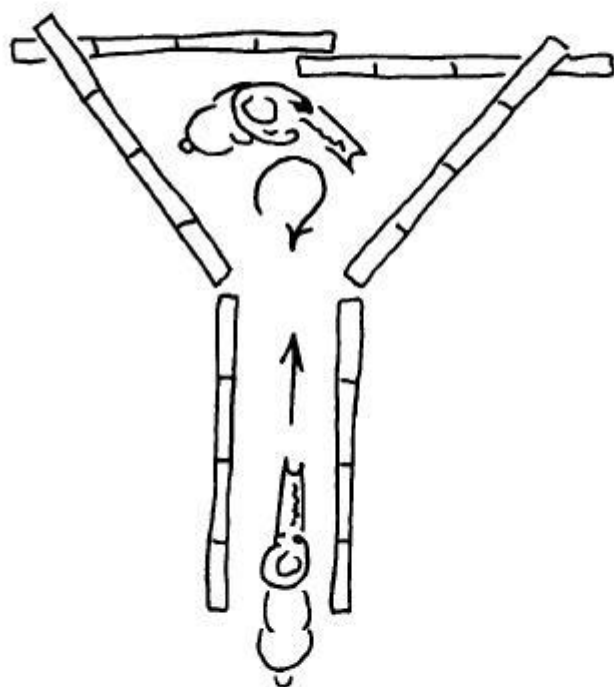
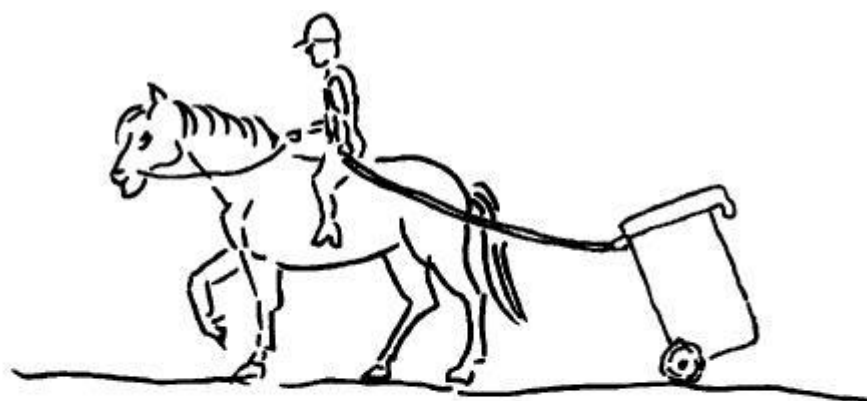

S16.11 Figures Court

The following diagrams show the dimensions necessary to draw the lines for the Figures tests. Dimensions are shown for both a 20x40m and 20x60m dressage courts.

<p style="text-align: center;">STEP 1: Large Circles</p> <p style="text-align: center;">These circles are used for all three levels. When marking the course for FG2 or FG3 the portions of the circles between the diagonal lines is not necessary.</p>	<p style="text-align: center;">STEP 2: Diagonals</p> <p style="text-align: center;">The diagonal lines are used for all three levels.</p>
<p style="text-align: center;">STEP 3: Small Circles (FG2)</p> <p style="text-align: center;">The small circles are only needed for FG2 (Figures level 2). They should not be marked for FG1 or FG3.</p>	<p style="text-align: center;">STEP 4: Tiny Circles (FG3)</p> <p style="text-align: center;">The tiny circles are only needed for FG3 (Figures level 3). They should not be marked for FG1 or FG2.</p>

